

Smart choice for power™

**xantrex**<sup>™</sup>  
A MISSION CRITICAL ELECTRONICS BRAND

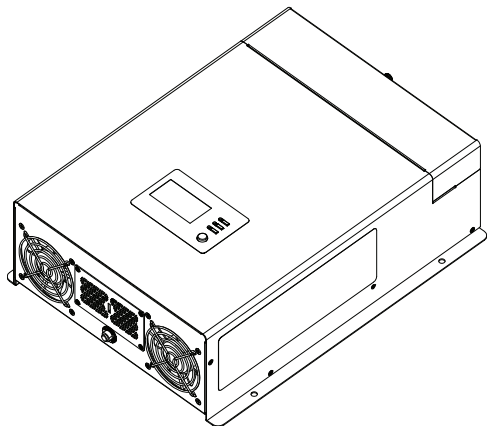

## Owner's Guide

# Freedom XC Inverter Charger

Freedom XC 1000 **817-1050**

Freedom XC 2000 **817-2080**

---

Copyright © 2018-2020 Xantrex LLC. All Rights Reserved.

All trademarks are owned by Xantrex LLC and its affiliates.

### **Exclusion for Documentation**

UNLESS SPECIFICALLY AGREED TO IN WRITING, SELLER

(A) MAKES NO WARRANTY AS TO THE ACCURACY, SUFFICIENCY OR SUITABILITY OF ANY TECHNICAL OR OTHER INFORMATION PROVIDED IN ITS MANUALS OR OTHER DOCUMENTATION;

(B) ASSUMES NO RESPONSIBILITY OR LIABILITY FOR LOSSES, DAMAGES, COSTS OR EXPENSES, WHETHER SPECIAL, DIRECT, INDIRECT, CONSEQUENTIAL OR INCIDENTAL, WHICH MIGHT ARISE OUT OF THE USE OF SUCH INFORMATION. THE USE OF ANY SUCH INFORMATION WILL BE ENTIRELY AT THE USER'S RISK; AND

(C) REMINDS YOU THAT IF THIS MANUAL IS IN ANY LANGUAGE OTHER THAN ENGLISH, ALTHOUGH STEPS HAVE BEEN TAKEN TO MAINTAIN THE ACCURACY OF THE TRANSLATION, THE ACCURACY CANNOT BE GUARANTEED. APPROVED CONTENT IS CONTAINED WITH THE ENGLISH LANGUAGE VERSION WHICH IS POSTED AT <http://www.xantrex.com/>.

**NOTE:** Visit <http://www.xantrex.com/>, click Products, select a Product category, select a Product, and search the Product Documents panel for a translation of the English guide, if available.

**Document Number:** 975-0784-01-01

Rev D

**Date:** August 2023

### **Product Names and Part Numbers**

Freedom XC 1000 (817-1050)

Freedom XC 2000 (817-2080)

### **Contact Information**

**Telephone:** (Toll Free USA/Canada) +1 800 670 0707 / (Outside USA/Canada) +1 408 987 6030

**Email:** [customerservice@xantrex.com](mailto:customerservice@xantrex.com),  
<http://www.xantrex.com/power-products-support/>

**Web:** <http://www.xantrex.com/>

---

## Information About Your System

As soon as you open your product, record the following information and be sure to keep your proof of purchase.

Serial Number \_\_\_\_\_  
Product Number \_\_\_\_\_  
Purchased From \_\_\_\_\_  
Purchase Date \_\_\_\_\_

To view, download, or print the latest revision, visit the website shown under **Contact Information**.

## Purpose

The purpose of this Owner's Guide is to provide explanations and procedures for installing, operating, configuring, maintaining, and troubleshooting a Freedom XC Inverter Charger for Recreational, Commercial and Fleet Vehicle, or Marine installations.

## Scope

The guide provides safety and operating guidelines as well as information on installing and configuring the inverter/charger. It also provides information about troubleshooting the unit. It does not provide details about particular brands of batteries. You need to consult individual battery manufacturers for this information.

## Audience

The guide is intended for users and operators of the Freedom XC Inverter Charger. The Installation section starting *on page 13* is intended for qualified personnel.

Qualified personnel have training, knowledge, and experience in:

- Installing electrical equipment.
- Applying all applicable installation codes.
- Analyzing and reducing the hazards involved in performing electrical work.
- Selecting and using Personal Protective Equipment (PPE).

## Abbreviations and Acronyms

A	Amperes
Ah	Amp-hours (a unit of battery capacity)
AC	Alternating Current [~]
ACC	Accessory in vehicle ignition system
AGM	Absorbed Glass Mat (a battery type)
BTS	Battery Temperature Sensor
DC	Direct Current [---]
GFCI	Ground Fault Circuit Interrupter
Hz	Hertz (a unit of frequency)
in-lb	inch-pound force (a unit of torque)
kW	Kilowatts ( 1000 watts)
LBCO	Low Battery Cutout (or Cutoff)
LCD	Liquid Crystal Display
LED	Light Emitting Diode
LFP	LiFePO <sub>4</sub> (lithium iron phosphate – a battery type)
N-m	Newton-meters (a unit of torque)
PN	Product Number
PPE	Personal Protective Equipment
s	Seconds (a unit of time)
V, VAC, VDC	Voltage, Volts AC, Volts DC
W	Wattage, watt (a unit of power)

## Related Information

You can find more information about Xantrex products and services at <http://www.xantrex.com/>.

# IMPORTANT SAFETY INSTRUCTIONS

READ AND SAVE THIS OWNER'S GUIDE FOR FUTURE REFERENCE.

This guide contains important safety instructions for the Freedom XC that must be followed during installation, operation, maintenance, and troubleshooting.

Read these instructions carefully and look at the equipment to become familiar with the device before installing, operating, configuring, maintaining, and troubleshooting it. The following special messages may appear throughout this documentation or on the equipment to warn of potential hazards or to call attention to information that clarifies or simplifies a procedure.



The addition of either symbol to a "Danger" or "Warning" safety label indicates that an electrical hazard exists which will result in personal injury if the instructions are not followed.



This is the safety alert symbol. It is used to alert you to potential personal injury hazards. Obey all safety messages that follow this symbol to avoid possible injury or death.

## DANGER

**DANGER** indicates a hazardous situation which, if not avoided, **will result in** death or serious injury.

## WARNING

**WARNING** indicates a hazardous situation which, if not avoided, **could result in** death or serious injury.

## CAUTION

**CAUTION** indicates a hazardous situation which, if not avoided, **could result in** minor or moderate injury.

## NOTICE

**NOTICE** is used to address practices not related to physical injury.

**IMPORTANT:** These notes describe things which are important for you to know, however, they are not as serious as a caution or warning.

**Please Note:** No responsibility is assumed by Xantrex for any consequences arising out of the use of this material.

## Product Safety Information

1. Before using the inverter/charger, read all instructions and cautionary markings on the unit, the batteries, and all appropriate sections of this guide.
2. Use of accessories not recommended or sold by the manufacturer may result in a risk of fire, electric shock, or injury to persons.
3. The inverter/charger is designed to be connected to both DC and AC electrical systems. The manufacturer recommends that all wiring be done by a certified technician or electrician to ensure adherence to the local and national electrical codes applicable in your jurisdiction.
4. To avoid a risk of fire and electric shock, make sure that existing wiring is in good condition and that wire is not undersized. Do not operate the inverter/charger with damaged or substandard wiring.
5. Do not operate the inverter/charger if it has been damaged in any way.
6. This unit does not have any user-serviceable parts. Do not disassemble the inverter/charger except where noted for connecting wiring and cabling. See your warranty for instructions on obtaining service. Attempting to service the unit yourself may result in a risk of electrical shock or fire. Internal capacitors remain charged after all power is disconnected.
7. To reduce the risk of electrical shock, disconnect both AC and DC power to or from the inverter/charger before attempting any maintenance or cleaning or working on any components connected to the inverter/charger. Do not

disconnect under load. Turning the inverter/charger to Standby using the Power button on the front panel will not reduce an electrical shock hazard.

8. The inverter/charger must be provided with an equipment-grounding conductor connected to the AC input ground.
9. Do not expose this unit to rain, snow, or liquids of any type. This product is designed for dry-locations-use only. Damp environments will significantly shorten the life of this product and corrosion caused by dampness will not be covered by the product warranty.
10. To reduce the chance of short-circuits, always use insulated tools when installing or working with this equipment.
11. Remove personal metal items such as rings, bracelets, necklaces, and watches when working with electrical equipment.
12. For marine applications, this unit must be installed with a drip shield. Refer to *Marine Installation on page 41* for details.

**⚠ DANGER**

### **ELECTRICAL SHOCK AND FIRE HAZARD**

Installation must be done by qualified personnel to ensure compliance with all applicable installation and electrical codes and regulations. Instructions for installing the Freedom XC Inverter Charger are provided here for use by qualified personnel only.

**Failure to follow these instructions will result in death or serious injury.**

**⚠ DANGER****HAZARD OF ELECTRIC SHOCK, EXPLOSION, BURN, OR ARC FLASH**

- Apply appropriate personal protective equipment (PPE) and follow safe electrical work practices. See NFPA 70E or CSA Z462.
- This equipment must only be installed and serviced by qualified electrical personnel.
- Never operate energized with the wiring compartment cover removed.
- Energized from multiple sources. Before removing the wiring compartment cover - identify all sources, de-energize, and wait 2 min for circuits to discharge.
- Always use a properly rated voltage sensing device to confirm all circuits are de-energized.
- Replace all devices, doors, and covers before turning on power to this equipment.

**Failure to follow these instructions will result in death or serious injury.**

**⚠ WARNING****FIRE AND EXPLOSION HAZARD**

- Unit's components may produce arcs or sparks.
- Do not install near batteries, in machinery space, or in an area in which ignition-protected equipment is required.

**Failure to follow these instructions can result in death, serious injury, or equipment damage.**

Areas include any space containing gasoline-powered machinery, fuel tanks, as well as joints, fittings, or other connections between components of the fuel system.

**⚠ WARNING****ELECTRICAL SHOCK HAZARD**

- Replace the wiring compartment cover before turning on power to this equipment.
- Use a torque screwdriver to tighten the captive nut panel screw to 5 in-lb (0.56 N-m) torque to ensure a proper ground connection and a required tool access to the wiring compartment.

**Failure to follow these instructions can result in death, serious injury, or equipment damage.**

## CAUTION

### ELECTRICAL SHOCK AND FIRE HAZARD

- Do not open. No serviceable parts inside. Provided with integral protection against overloads. Bonding between conduit connections is not automatic and must be provided as part of the installation.
- Read guide before installing or using.
- Do not cover or obstruct ventilation openings.
- Do not mount in zero-clearance compartment – overheating may result.
- Do not expose to rain or spray. This inverter/charger is designed for marine applications only when additional drip protection is installed in certain orientations. See *"Approved Mounting Orientations"* on page 23 for more information.
- Install GFCIs only as specified in this guide. Other types may fail to operate.
- Do not connect AC OUT to any source of power. Damage to unit may occur.
- For AC IN and AC OUT, use wires suitable for at least 75°C.

**Failure to follow these instructions can result in injury or equipment damage.**

### NOTES:

- Follow these instructions and those published by the battery manufacturer and the manufacturer of any equipment you intend to use in the vicinity of the battery. Review cautionary markings on these products and on the engine.
- Freedom XC Inverter Charger products are designed for deep cycle lead-acid batteries. See warning below when connecting to lithium ion batteries.
- Do not use transformerless battery chargers in conjunction with the inverter/charger due to overheating.

## CAUTION

### LITHIUM ION BATTERY TYPE HAZARD

Make sure to use a lithium ion battery pack that includes a certified Battery Management System (BMS) with built-in safety protocols. Follow the instructions published by the battery manufacturer.

**Failure to follow these instructions can result in serious injury or equipment damage.**



**⚠ CAUTION****PHYSICAL INJURY HAZARD**

This Freedom XC Inverter Charger is not intended for use by persons (including children) with reduced physical, sensory, or mental capabilities or lack of experience and knowledge, unless they have been given supervision or instruction concerning use of the appliance by a person responsible for their safety. Children should be supervised to ensure that they do not play with the appliance.

**Failure to follow these instructions can result in injury or equipment damage.**

**Precautions When Working With Batteries**

**IMPORTANT:** Battery work and maintenance must be done by qualified personnel knowledgeable about batteries to ensure compliance with battery handling and maintenance safety precautions.

**⚠ WARNING****BURN FROM HIGH SHORT-CIRCUIT CURRENT, FIRE AND EXPLOSION FROM VENTED GASES HAZARDS**

- Always wear proper, non-absorbent gloves, complete eye protection, and clothing protection. Avoid touching your eyes and wiping your forehead while working near batteries. See note #4 below.
- Remove all personal metal items, like rings, bracelets, and watches when working with batteries. See notes #5 and #6 below.
- Never smoke or allow a spark or flame near the engine or batteries.
- Never charge a frozen battery.
- Never charge a Lithium Ion type battery with an ambient of 0 °C (-32 °F) or colder.

**Failure to follow these instructions can result in death, serious injury, or equipment damage.**

**NOTES:**

1. Mount and place the Freedom XC Inverter Charger unit away from batteries in a well ventilated compartment.
2. Always have someone within range of your voice or close enough to come to your aid when you work near a lead-acid battery.
3. Always have plenty of fresh water and soap nearby in case battery acid contacts skin, clothing, or eyes.
4. Keep battery terminals clean from corrosion. If battery acid or corrosion deposit contacts skin or clothing, wash immediately with soap and water. If battery acid or corrosion deposit enters your eye, immediately flood it with running cold water for at least twenty minutes and have someone within range of your voice or close enough to get medical attention immediately.
5. Use extra caution to reduce the risk of dropping a metal tool on the battery. It could spark or short circuit the battery or other electrical parts and could cause an explosion. Use tools with insulated handles only.
6. Batteries can produce a short circuit current high enough to weld a ring or metal bracelet or the like to the battery terminal, causing a severe burn.
7. When removing a battery, always remove the negative terminal from the battery first for systems with grounded negative. If it is grounded positive, remove the positive terminal first. Make sure all loads connected to the battery and all accessories are off so you don't cause an arc.

## Precautions When Placing the Unit

### **WARNING**

#### **FIRE HAZARD**

- Do not install the inverter/charger or any part of its supplied wiring in engine compartments.
- For marine installation, always locate the inverter/charger away from the battery and mounted separately in a well-ventilated compartment with adequate space.

**Failure to follow these instructions can result in death, serious injury, or equipment damage.**

### **CAUTION**

#### **BURN HAZARD**

Avoid touching the external surfaces - heatsink may be hot.

**Failure to follow these instructions can result in injury or equipment damage.**

## NOTICE

### RISK OF INVERTER/CHARGER DAMAGE

- Never allow battery acid to drip on the inverter/charger when reading specific gravity, or filling battery.
- Never place the Freedom XC unit directly above batteries; gases from a battery will corrode and damage the inverter/charger.
- Do not place a battery on top of the inverter/charger.

**Failure to follow these instructions can result in equipment damage.**

## Regulatory

The Freedom XC inverter/charger is certified to appropriate US and Canadian standards. For more information see *Regulatory approvals on page 92*

The Freedom XC inverter/charger is intended to be used for Recreational, Commercial and Fleet Vehicle, or Marine installations. This inverter/charger is designed for marine applications only when additional drip protection is installed in certain orientations. See the section on Marine Installation for information.

## EMI Information to the User

This equipment has been tested and found to comply with the limits for a Class B digital device, pursuant to part 15 of the FCC / ISED CAN ICES-003 Rules. These limits are designed to provide reasonable protection against harmful interference in a residential environment. This equipment generates, uses, and can radiate radio frequency energy and, if not installed and used in accordance with the instructions, may cause harmful interference to radio communications.

However, there is no guarantee that interference will not occur in a particular installation. If this equipment does cause harmful interference to radio or television reception, which can be determined by turning the equipment off and on, the user is encouraged to try to correct the interference by one or more of the following measures:

- Reorient or relocate the receiving antenna.
- Increase the separation between the equipment and receiver.
- Connect the equipment into an outlet on a circuit different from that to which the receiver is connected.
- Consult the dealer or an experienced radio/TV technician for help.

## CAUTION

Unauthorized changes or modifications to the equipment could void the user's authority to operate the equipment.

## End of Life Disposal

The Freedom XC Inverter Charger is designed with environmental awareness and sustainability in mind. At the end of its useful life, the Freedom XC can be decommissioned and disassembled.

Components which can be recycled must be recycled and those that cannot be recycled must be disposed of according to local, regional, or national environmental regulations.

Many of the electrical components used in the Freedom XC are made of recyclable material like steel, copper, aluminum, and other alloys. These materials can be auctioned off to traditional scrap metal recycling companies who resell reusable scraps.

Electronic equipment such as the circuit boards, connectors, and fuses can be broken down and recycled by specialized recycling companies whose goal is to avoid having these components end up in the landfill.

For more information on disposal, contact Xantrex.

# CONTENTS

Important Safety Instructions .....	<i>v</i>	Step 2: Choosing a Location for the Unit .....	22
Product Safety Information .....	<i>vi</i>	Step 3: Mounting the Unit .....	23
Precautions When Working With Batteries .....	<i>ix</i>	Step 4: Connecting the AC Input Wires .....	25
Precautions When Placing the Unit .....	<i>x</i>	Step 5: Connecting AC Output to an Existing AC Circuit .....	29
Regulatory .....	<i>xi</i>	Step 6: Connecting the DC Cables .....	31
EMI Information to the User .....	<i>xi</i>	Step 7: Connecting to Port(s) on the Freedom XC .....	36
End of Life Disposal .....	<i>xii</i>	Step 8: Testing Your Installation .....	38
Introduction .....	1	Marine Installation .....	41
Materials List .....	2	Drip Shield Installation .....	42
Key Features .....	2	Operation .....	43
Features .....	7	Freedom XC Display Panel .....	44
AC/DC and GFCI Panel .....	8	Status LED Indicators .....	44
Display Panel .....	10	Function Buttons .....	45
Side Panel .....	11	LCD Screen .....	45
Installation .....	13	LCD Screen Icons .....	46
Before You Begin the Installation .....	14	Viewing Information During Battery Mode .....	47
Installation Codes .....	14	Viewing Information During Grid Mode .....	49
Basic Installation Procedures .....	15	Adjusting Settings in Configuration Mode .....	51
Installation Tools and Materials .....	15	Settings .....	53
Step 1: Designing the Installation .....	16	Operating in Battery Mode .....	58
		Turning Inverter Operation ON .....	58
		Power Save Timer .....	59

Power Save Mode .....	59	Pre-service Checklist .....	74
Checking Battery Status .....	59	Warning Messages .....	75
Checking Output Power .....	59	Troubleshooting Reference .....	78
Operating Several Loads at Once .....	59	Inverter Applications .....	82
Turning the Audible Alarm ON or OFF .....	60	Resistive Loads .....	82
Operating in Grid Mode .....	61	Motor Loads .....	82
Battery Charger Functions .....	61	Problem Loads .....	83
Battery Types .....	61	<b>Specifications .....</b>	<b>85</b>
Custom Battery Settings Menu .....	65	Physical Specifications .....	86
Operating During Transition Between Grid Mode and Battery		Environmental Specifications .....	87
Mode .....	65	System Specifications .....	88
Transitioning from Grid Mode to Battery Mode .....	66	Regulatory Approvals .....	92
Transitioning from Battery Mode to Grid Mode .....	66		
Operating Limits .....	66		
Power Output .....	67		
Input Voltage .....	67		
Overload Conditions .....	69		
High Surge Loads .....	69		
Over-temperature Conditions .....	69		
<b>Routine Maintenance .....</b>	<b>71</b>		
Maintaining the Freedom XC Unit .....	72		
<b>Troubleshooting .....</b>	<b>73</b>		

# 1 INTRODUCTION

The Freedom XC Inverter Charger is designed with integrated inverting and charging functions and power management features suitable for Recreational, Commercial and Fleet Vehicle, or Marine installations.

Please read this section to familiarize yourself with the main performance and protection features of the Freedom XC. This section includes:

<b>Materials List</b> .....	<b>2</b>
<b>Key Features</b> .....	<b>2</b>

## Materials List

The Freedom XC base package includes the following items:

- one Freedom XC unit
- one Owner's Guide and extra safety labels
- one pre-installed DC ground enclosure lug (not shown)
- one set of plastic bushings for large DC cables<sup>a</sup> (not shown)

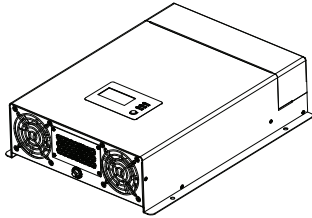

Figure 1 What's In The Box

**NOTE:** If any of the items are missing, contact Xantrex or any authorized Xantrex dealer for replacement. See *Contact Information on page ii*.

<sup>a</sup>Available only to the Freedom XC 2000 only.

## Key Features

### Power for Most Appliances

The Freedom XC inverter/charger provides up to 1000 watts (Freedom XC 1000) or 2000 watts<sup>2</sup> (Freedom XC 2000) of continuous utility grade, sine wave power derived from a battery bank. It is designed to handle loads such as microwave ovens, TVs, DVD/Blu-ray players, and power tools. In addition, the Freedom XC's high-surge capability lets you handle many hard-to-start loads, including full size residential refrigerators.

The built-in transfer switch automatically transfers between inverter power and shore power from recreational facilities such as boat docks or campsites to ensure power is always available.

<sup>2</sup> As the temperature on the Freedom XC rises, it will gradually reduce its continuous power output from 2000 W at 40°C ambient to 1500 W before the over-temperature shutdown occurs at 60°C ambient. See *Specifications on page 85*.



**Back-up  
Capability**

If incoming shore power is interrupted by external events like brownouts, the Freedom XC automatically becomes an independent power source<sup>3</sup> that supplies utility grade AC power to your loads.

**Comprehensive  
Protection**

The Freedom XC's built-in protection features safeguard your batteries (from unnecessary drain) such as the low battery voltage alarm and shutdown and protect equipment such as a configurable AC transfer speed.

- **Selectable Low Battery Shutdown:**  
The low battery shutdown for the inverter/charger can be manually selected by the user from 10.1 to 12.8 VDC.
- **Voltage Shutdown Delay Timer:**  
Configurable from 1 to 300 s to reduce an unnecessary shutdown of inverter operation such as during cranking or other brief but heavy discharge of battery.

- **Inverter Power Save:** The Freedom XC can be programmed to automatically turn off after 1 to 25 h of continued operation of loads that are under 50 W. It is designed, with LBCO (low battery cut off), to prevent the battery from deep discharge.

**Configurable AC  
Transfer Speed**

The Freedom XC allows two speed settings for the AC transfer from Grid Mode to Battery Mode and vice versa which avoids nuisance resetting of appliances. The normal transfer rate is for common appliances and the faster transfer rate is designed for more sensitive digital equipment like a desktop computer.

**Overload Alarm  
and Shutdown**

During Battery Mode (also called Inverter Mode), the Freedom XC automatically alerts you if the loads that are connected and drawing power from the unit are close to approaching the maximum operating limit. If so, the Freedom XC automatically shuts down when the maximum operating limit is exceeded. See *Troubleshooting Reference on page 78* for precautions.

---

<sup>3</sup>Assuming the inverter/charger is connected to a battery source with an adequate charge at the time of the power interruption.

<b>Over temperature Alarm and Shutdown</b>	During Battery Mode, the Freedom XC automatically alerts you if it is overheating and approaching the over-temperature shutdown limit. The Freedom XC automatically shuts down when the limit is exceeded. See <i>Troubleshooting Reference on page 78</i> for precautions.	<b>Dead Battery Charging</b>	Another feature of the Freedom XC is dead battery charging. This is the ability to recharge batteries, even if the battery voltage has reached 0 VDC.
<b>Built-in Charge Formulas</b>	For the inverter/charger to perform at the highest level, the batteries must be charged correctly. The Freedom XC has optimized algorithms for flooded, gel, AGM, custom, and lithium iron phosphate [LFP (or LiFePO <sub>4</sub> )] Xantrex Batteries.	<b>Ignition Control</b>	The Freedom XC provides two user-selectable options for ignition control: <ul style="list-style-type: none"><li>■ <b>Ignition Auto-on:</b> The Freedom XC can automatically turn the inverter/charger on and off in tandem with the vehicle's ignition circuit or a manually operated remote switch.</li><li>■ <b>Ignition Lockout:</b> The Freedom XC features the ability to inhibit the inverter/charger from operating in the absence of a voltage signal from a vehicle's ignition circuit. This is particularly useful if the inverter/charger is required to operate only when a vehicle's engine is running.</li></ul>
<b>Manual Equalization</b>	Over a period of time, the cells in a flooded battery can develop uneven chemical states. This can result in a weak (undercharged) cell which, in turn, can reduce the overall capacity of the battery. To improve the life and performance of a non-sealed, flooded battery, the Freedom XC multi-stage charging cycle includes a manual equalize mode that can be used, if recommended by the battery manufacturer.	<b>Configurable AC Output Frequency and Voltage</b>	The Freedom XC is factory set to 60 Hz AC output frequency and 120 V AC output voltage. It can be configured to 50 Hz for use in regions outside the USA and Canada. The AC voltage setting can also be configured to either of three settings: 108, 110, or 120 volts.

**Load  
Management**

The Freedom XC has a built-in 30A transfer relay (Freedom XC 1000) that connects the inverter/charger output or AC input from the AC generator to the loads. Because the usual AC power sources such as small generators often have limited current availability, having the capability to manage your AC loads is extremely valuable. The Freedom XC provides a number of features to facilitate this.

- The charger is power factor corrected to use AC current as efficiently as possible. Minimizing the AC current used by the charger means more current is available for your AC loads.
- The Freedom XC has a power share feature which prioritizes your AC loads by reducing the charge current and maintaining the total input current to less than the breaker setting.



---

## 2 FEATURES

This section identifies the default settings and the hardware features of the Freedom XC Inverter Charger. This section includes:

<b>AC/DC and GFCI Panel</b> .....	<b>8</b>
<b>Display Panel</b> .....	<b>10</b>
<b>Side Panel</b> .....	<b>11</b>

# AC/DC and GFCI Panel

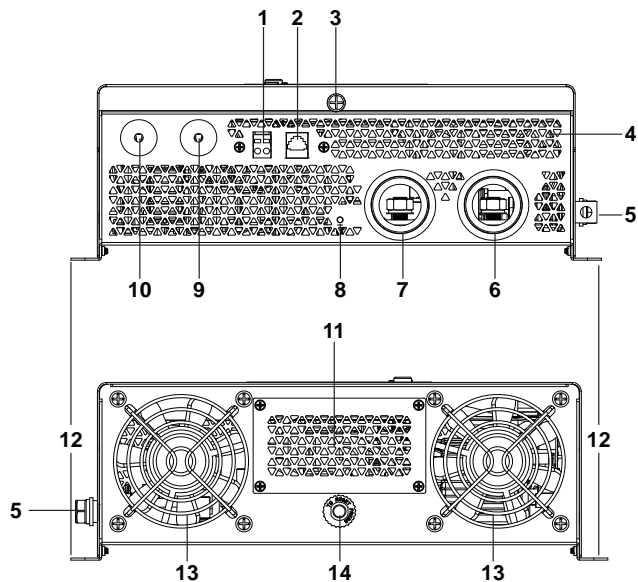

Figure 2 AC/DC and GFCI Panel

## ⚠ WARNING

### ELECTRICAL SHOCK HAZARD

Use a torque screwdriver to tighten the captive nut panel screw to 5 in-lb (0.56 N-m) torque of force to ensure a proper ground connection and a required tool access to the wiring compartment.

**Failure to follow these instructions can result in death, serious injury, or equipment damage.**

Table 1 AC/DC and GFCI Panel Features

Item	Description
1	<b>ACC input terminal</b> for connecting ignition control wiring. Ignition Control Switch (ACC) for connecting [ON (I)] and disconnecting [OFF (O)] the ignition signal.
2	<b>Remote port</b> allows you to connect an accessory remote control / display device.
3	<b>Captive nut panel screw</b> holds the wiring compartment cover in place. See <i>WARNING on page 8</i> .
4	<b>Ventilation grille</b> (openings) must not be obstructed.
5	<b>DC Grounding lug</b> provides a ground path for the Freedom XC chassis to the DC system ground. See <i>WARNING on page 9</i> .

Item	Description
6	<b>DC terminal</b> opening for routing (–) negative DC cable.
7	<b>DC terminal</b> opening for routing (+) positive DC cable.
8	<b>LED alert indicator</b> for reverse DC polarity.
9	<b>AC output terminal opening</b> for routing AC output wiring.
10	<b>AC input terminal opening</b> for routing AC input wiring.
11	<b>GFCI cover</b> is removed when installing a qualified GFCI device such as the optional GFCI kit (sold separately; order PN: 808-9817).
12	<b>Mounting flanges</b> on both sides allow you to mount the inverter/charger permanently on the interior deck or on a wall.
13	<b>Ventilation grille</b> (openings) must not be obstructed for the proper operation of the cooling fan and inverter/charger. When the inverter/charger is mounted, the ventilation grille must not point up or down. <b>Cooling fans</b> turn on when the internal temperature reaches a set point temperature.
14	<b>20 A supplementary protector with reset button</b> provides overload protection for the optional GFCI kit (sold separately; order PN: 808-9817). Press to recover from an overload condition. In a hard wired installation, the supplementary protector does not protect output wiring.

## **WARNING**

### **ELECTRICAL SHOCK HAZARD**

- Use a torque screwdriver to tighten the bolt on the DC ground lug to a torque of 23 in-lb (2.6 N-m) of force.
- Apply an anti-corrosion compound to the copper wire prior to connecting to the DC ground lug.

**Failure to follow these instructions can result in death, serious injury, or equipment damage.**

# Display Panel

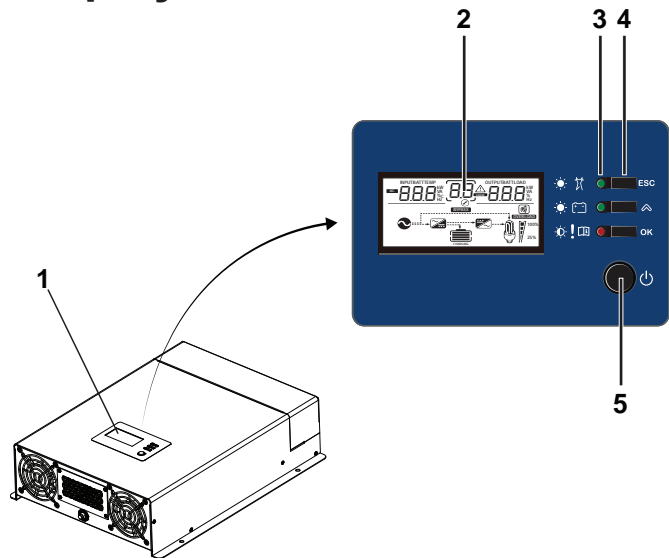

Figure 3 Display Panel

Table 2 Display Panel Features

Item	Description
1	<b>Display panel</b> displays status information on the screen. It is comprised of a display screen, LEDs, and buttons.
2	<b>Multi-function LCD screen</b> shows status information and error codes.
3	<b>Status LEDs</b> indicate the mode of operation.
4	Three <b>function buttons</b> change status information displayed on the screen. Also, changes inverter/charger settings. See <i>Freedom XC Display Panel on page 44</i> for detailed information on the panel's buttons.
5	<b>Power [Standby] button</b> is pressed for turning on the unit. The inverter turns on for the loads and when applicable, the charger turns on automatically.



# Side Panel

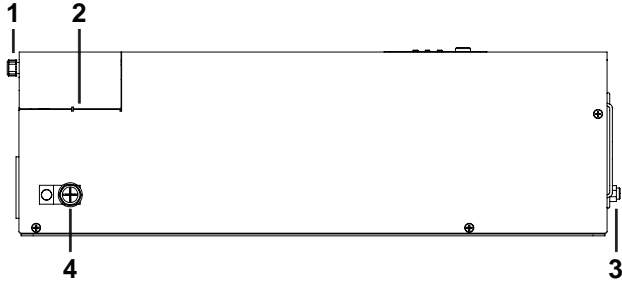

Figure 4 Side Panel

## **⚠ WARNING**

### **ELECTRICAL SHOCK HAZARD**

- Use a torque screwdriver to tighten the captive nut panel screw to 5 in-lb (0.56 N-m) torque to ensure a proper ground connection and a required tool access to the wiring compartment.
- Use a torque screwdriver to tighten the bolt on the DC ground lug to a torque of 23 in-lb (2.6 N-m) of force.
- Apply an anti-corrosion compound to the copper wire prior to connecting to the DC ground lug.

**Failure to follow these instructions can result in death, serious injury, or equipment damage.**

Table 3 Side Panel Features

Item	Description
1	<b>Captive nut panel screw</b> holds the wiring compartment cover in place. See <b>WARNING on page 11</b> .
2	<b>Wiring compartment cover</b> protects the wiring compartment from debris and keeps the cables secure. Using the captive nut panel screw, the cover can be opened and lifted out during wiring. See <b>WARNING on the left</b> .
3	<b>20 A supplementary protector with reset button</b> provides overload protection for the optional GFCI kit (sold separately; order PN: 808-9817). Press to recover from an overload condition. In a hard wired installation, the supplementary protector does not protect output wiring.
4	<b>DC Grounding lug</b> provides a ground path for the Freedom XC chassis to the DC system ground. See <b>WARNING on page 9</b> .



## 3 INSTALLATION

Please read this section for safety information and installation instructions regarding your Freedom XC. This section includes:

<b>Before You Begin the Installation</b> .....	<b>14</b>
<b>Installation Codes</b> .....	<b>14</b>
<b>Basic Installation Procedures</b> .....	<b>15</b>
Installation Tools and Materials .....	15
Step 1: Designing the Installation .....	16
Step 2: Choosing a Location for the Unit .....	22
Step 3: Mounting the Unit .....	23
Step 4: Connecting the AC Input Wires .....	25
Step 5: Connecting AC Output to an Existing AC Circuit .....	29
Step 6: Connecting the DC Cables .....	31
Step 7: Connecting to Port(s) on the Freedom XC .....	36
Step 8: Testing Your Installation .....	38
<b>Marine Installation</b> .....	<b>41</b>
Drip Shield Installation .....	42

## Before You Begin the Installation

### **WARNING**

#### **ELECTRICAL SHOCK AND FIRE HAZARD**

- All wiring should be done by qualified personnel to ensure compliance with all applicable installation codes and regulations.
- Do not connect to AC and DC power sources during installation. Disconnect from all power sources when servicing.
- Disable and secure all AC and DC disconnect devices and automatic generator starting devices.

**Failure to follow these instructions can result in death, serious injury, or equipment damage**

Before beginning your installation:

- Read this entire Installation guide so you can plan the installation from beginning to end.
- Assemble all the tools and materials you require for the installation.
- Review the *Important Safety Instructions on page v*
- Be aware of all safety and electrical codes which must be met.

## Installation Codes

Governing installation codes vary depending on the specific location and application of the installation. Some examples include the following:

- The U.S. National Electrical Code (NEC)
- The Canadian Electrical Code (CEC)
- The U.S. Code of Federal Regulations (CFRs)
- Canadian Standards Association/CSA Group (CSA) and the RV Industry Association (RVIA) standards and codes for installations in RVs
- The American Boat and Yacht Council (ABYC) standards and US Coast Guard Regulations (33CFR183, Sub Part I) for Marine installations in the U.S.

It is the installer's responsibility to ensure that all applicable installation requirements are met.

## Basic Installation Procedures

This section provides sample installation information as a guide for your installation. For your convenience, the overall procedure is divided into these main steps:

<b>Installation Tools and Materials</b> .....	<b>15</b>
<b>Step 1: Designing the Installation</b> .....	<b>16</b>
<b>Step 2: Choosing a Location for the Unit</b> .....	<b>22</b>
<b>Step 3: Mounting the Unit</b> .....	<b>23</b>
<b>Step 4: Connecting the AC Input Wires</b> .....	<b>25</b>
<b>Step 5: Connecting AC Output to an Existing AC Circuit</b> ..	<b>29</b>
<b>Step 6: Connecting the DC Cables</b> .....	<b>31</b>
<b>Step 7: Connecting to Port(s) on the Freedom XC</b> .....	<b>36</b>
<b>Step 8: Testing Your Installation</b> .....	<b>38</b>

**NOTE:** For marine applications, see additional installation instructions *on page 41*.

## Installation Tools and Materials

You will need the following to install the Freedom XC:

- Wire stripper
- Mounting (#2) screws or bolts
- #2 Phillips torque screwdriver
- Torque wrench for DC terminals (½" or 13mm socket wrench)
- AC cable (that is, two-conductor-plus-ground cable), sized appropriately for load and application
- ½" (or ¾") trade-size strain relief clamps (for the AC cable clamp holes)
- Wire nuts or crimp connectors for AC wire and appropriate tools
- DC cable, sized appropriately for load and application
- Lugs for DC cables to fit  $\frac{5}{16}$ " DC stud terminals as well as appropriate tools (like a crimping tool)
- AC and DC disconnects and over-current protective devices

## Step 1: Designing the Installation

Most Freedom XC installations share common components, and some of these are briefly described in *Step 1: Designing the Installation*.

*Figure 5* shows some components and their relationship to each other in a typical recreational vehicle or fleet vehicle installation. Also, see *Marine Installation on page 41*.

1	DC Equipment ground
2	Freedom XC
3	DC fuse/disconnect/DC circuit breaker
4	12V deep cycle battery [house]
5	Battery isolator
6	Alternator
7	To engine
8	DC Equipment ground
9	Starting battery
10	AC load panel
11	AC source panel
12	Selector switch
13	Shore power
14	Generator

*Figure 5 Typical Recreational Vehicle and Fleet Vehicle Installation*

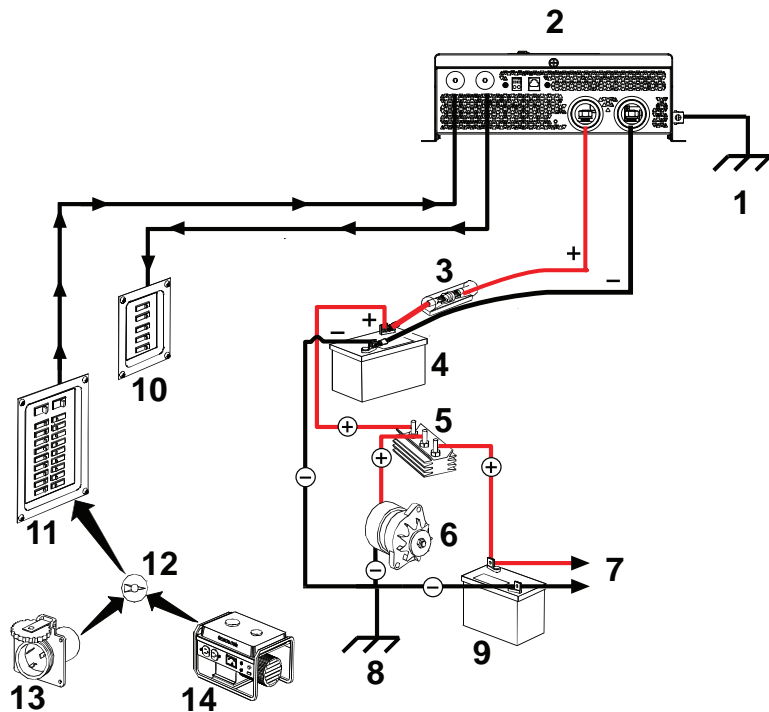

## AC Shore Power

A source of 120 volts AC 60Hz sine wave alternating current provides energy to pass power through to AC loads. This source is usually the utility grid (power company) or an AC generator. An automatic or manual AC source selector switch can be used to switch between the multiple sources of shore power to the Freedom XC system.

The AC source feeding the Freedom XC must have the neutral conductor bonded to ground. When the inverter/charger passes shore power through, it will lift its internal bonding relay on the output and will rely on the input neutral being bonded in order to ensure that the power delivered to a sub panel is properly bonded. See *AC Output Neutral Bonding on page 19* for more information on bonding relay operation.

**NOTE:** Throughout this guide, the term “shore power” refers to AC input power from a utility grid, generator, or other AC source.

## AC Disconnect and Over-Current Protection Device

Most safety requirements and electrical codes require the Freedom XC’s AC and DC inputs and outputs to be provided with over-current protection (such as branch-rated circuit breakers or fuses) and disconnect devices.

### AC Input

The branch-rated circuit breaker or fuse (connected through hard wiring) that is used to supply the Freedom XC must be rated at no more than 30A and must be approved for use on 120 volts AC branch circuits. The wire used between the breaker and the Freedom XC input must be sized adequately to carry current up to the rating of the input breaker and in accordance with the electrical codes or regulations applicable to your installation.

### AC Output

The branch-rated circuit breaker or fuse must be rated at no more than the rating of the input breaker in the installation and must be approved for use on 120 volts AC branch circuits. The wire used between the Freedom XC and the AC output breaker must be of adequate size to match the AC input circuit breaker’s rating. The wiring from each AC output breaker to each of the loads must be adequately sized to carry the current rating of the individual AC output breaker.

**Disconnect Devices** Each system requires a method of disconnecting the AC circuits. If the over-current protection devices are circuit breakers, they will also serve as the disconnects. If fuses are used, separate AC disconnect switches will be needed ahead of the fuses. These will have to be a branch circuit rated for 120 volts AC and have an appropriate current rating.

## AC Distribution Panels

Most systems incorporate distribution centers both ahead of the Freedom XC (the AC source panel) and between the Freedom XC and the loads (the AC load panel). An AC source panel includes a main circuit breaker, which serves as over-current protection and as a disconnect for the AC shore power supply line. Additional circuit breakers serve individual circuits, one of which serves the Freedom XC. The AC load panel can incorporate an AC output circuit breaker and breakers for individual load circuits.

## AC Cabling

AC cabling includes all the wires and connectors between the AC source and the Freedom XC, as well as all AC cabling between the Freedom XC and the AC output panels, circuit breakers, and loads. The type and size of the wiring varies with the installation and load. For example, in high vibration environments, such as marine or RV applications, wire nuts may not be acceptable, so crimp splices would be required. In other applications, flexible multiple-strand wire may be required. Installation codes usually specify solid or stranded, overall size of the conductors, and type and temperature rating of the insulation around the wire.



AC breakers and fuses must be sized to adequately protect the wiring that is installed on the input and output AC circuits of the Freedom XC. All breakers and wiring must be sized and connected in accordance with the electrical codes or regulations applicable to your installation. *Table 4* gives some examples of wiring sizes based on the U.S. National Electrical Code and the Canadian Electrical Code. These examples are based on using a two-conductor-plus-ground copper cable rated at 60 °C, and assuming an ambient temperature of up to 30 °C. Ensure that your breakers and fuses have suitable temperature ratings for your wiring. Other codes and regulations may also be applicable to your installation.

*Table 4 Required AC Wire Size vs Breaker Rating*

Breaker Size (A)	10A	15A	20A	30A
Minimum Wire Size (AWG)	14AWG	14AWG	12AWG	10AWG

## AC Output Neutral Bonding

The neutral conductor of the Freedom XC's AC output circuit (that is, AC Output Neutral) is automatically connected to the safety ground during inverter operation. When AC utility power is present this connection is not present, so that the utility neutral (that is, AC Input Neutral) is only connected to utility ground at your source. This conforms to the National Electrical Code (NEC), which requires that separately derived AC sources (such as inverters and generators) have their neutral conductors tied to ground in the same way that the neutral conductor from the utility is tied to ground in only one place. Check the regulations for your specific application to ensure that the installation will comply with the necessary requirements. In other words, the AC Input Neutral ground bonding and Output Neutral ground bonding must be isolated from each other.

## AC Grounding

As per UL458 SA29.5, for all permanently connected marine inverters: The Freedom XC should be connected to a grounded, metal, permanent wiring system. Also, make sure that an AC ground wire is connected to the AC ground terminal on the unit. Do not just connect the line and neutral wires.

All connections to the unit shall comply with all regulations, directives, local codes and ordinances.

## Ground Fault Circuit Interrupters (GFCIs)

A GFCI is a device that de-energizes a circuit when a current to ground exceeds a specified value that is less than that required to blow the circuit breaker. GFCIs are intended to protect people from electric shocks and are usually required in wet or damp locations.

Installations in marine and recreational vehicles require GFCI protection of branch circuits connected to the AC output of the Freedom XC.

The following GFCI receptacle will work correctly with the Freedom XC in the inverter/charger's AC output distribution wiring system.

*Table 5 GFCI*

Make	Model
Eaton/Cooper	SGF20W

Alternatively, the Freedom XC GFCI kit (sold separately; order PN: 808-9817) option is also available to use with the Freedom XC inverter unit. See item *11 on page 9*.

## DC Cabling

This includes all the cables and connectors between the batteries, the DC disconnect and over-current protection device, and the Freedom XC. Most mobile installations require multi-strand insulated copper cables for flexibility and durability in high vibration environments and require disconnects and over-current devices. Electrical wiring sizes in North America are indicated by AWG notation. In other parts of the world, the metric system is used. Under the AWG standard, a larger gauge number indicates a smaller wire diameter. Wire size is usually marked on the larger sized cables. *Table 6* specifies the minimum recommended DC cable size and maximum fuse size for the Freedom XC. **The DC cables must be stranded, copper, and must be rated 90 °C minimum.** The cables should be terminated with lugs that fit the DC stud terminals snugly ( $\frac{5}{16}$ " hole size) and properly torqued according to manufacturer-specified torque setting.

Table 6 Required Cable Sizes

Inverter/charger	Cable Length: Battery to Inverter (one way)	Minimum Cable Size	Maximum battery Fuse Size
Freedom XC 1000	Less than 5 feet (1.5 meters)	No. 2 AWG	150 A DC
Freedom XC 2000		No. 2/0 AWG	250 A DC
<b>NOTE:</b> It is not recommended using a cable longer than 5 feet (1.5 meters) in each direction. North American cable sizes above are based on the US National Electrical Code Table 310.17 - 75 °C cables, assuming an ambient temperature of 30 °C cables.			

**IMPORTANT:** Using the correct cable size is critical to achieving the rated performance of the Freedom XC unit. When starting a heavy load the Freedom XC can draw current surges from the battery of up to 400A. If the DC wiring is too small the voltage drop from this surge will result in a voltage at the Freedom XC terminals that is too low for the Freedom XC to operate correctly. The Freedom XC may appear to operate correctly with smaller cables until a heavy load such as a microwave or refrigerator attempts to start - then the unit may work correctly sometimes and not work correctly other times.

## DC Disconnects and Over-Current Devices

The DC circuit from the battery to the Freedom XC must be equipped with a disconnect and over-current device. This usually consists of a circuit breaker, a “fused-disconnect”, or a separate fuse and DC disconnect. **Do not confuse AC circuit breakers with DC circuit breakers.** They are not interchangeable. The rating of the fuse or breaker must be matched to the size of cables used in accordance with the applicable installation codes. The breaker or disconnect and fuse should be located as close as possible to the battery, in the positive cable. Applicable codes may limit how far the protection can be from the battery.

## Batteries

The Freedom XC uses 12-volt battery banks. Every Freedom XC system is recommended to have a deep-cycle battery (house) or group of batteries with a total capacity of 100 Ah or more which provides the DC current that the Freedom XC converts to AC.

## Step 2: Choosing a Location for the Unit

### WARNING

#### FIRE AND EXPLOSION HAZARDS

- Do not install the Freedom XC in compartments containing batteries or flammable materials, or in locations that require ignition-protected equipment. This includes any space containing gasoline-powered machinery, fuel tanks, or joints, fittings, or other connections between components of the fuel system. This equipment contains components that tend to produce arcs or sparks.
- Do not install on or over combustibles surfaces.
- Do not cover or obstruct the ventilation openings.
- Do not install the Freedom XC in a zero-clearance compartment. Overheating may result.

**Failure to follow these instructions can result in death, serious injury, or equipment damage.**

The Freedom XC should only be installed in locations that meet the following requirements:

- **Dry.** Do not allow water or other fluids to drip or splash on the Freedom XC. **Do not mount the Freedom XC in an area subject to splashing water or bilge water.**

- **Cool.** Normal air temperature should be between -20 °C and 40 °C (-4 °F and 104 °F)—the cooler the better, for increased efficiency and product life extension.
- **Ventilated.** Allow at least 5 inches of clearance at the fan end of the Freedom XC for air flow, 1 inch on each side, and 2 inches at the wiring access (AC and DC) end. The more clearance for ventilation around the unit, the better the performance. Do not allow the ventilation openings on the ends of the unit to become obstructed.
- **Safe.** Do not install the Freedom XC in the same compartment as batteries or in any compartment capable of storing flammable liquids like gasoline.
- **Close to the battery compartment and the AC source and load panels.** Avoid excessive cable lengths (which reduce input and output power due to wire resistance). Use the recommended cable lengths and sizes, especially between the battery banks and the Freedom XC.
- **Protected from battery acid and gases.** Never allow battery acid to drip on the Freedom XC or its wiring when reading specific gravity or filling the battery. Also do not mount the unit where it will be exposed to gases produced by the batteries. These gases are very corrosive, and prolonged exposure will damage the Freedom XC.

## Step 3: Mounting the Unit

### To mount the Freedom XC:

1. Remove the Freedom XC from its shipping container, verify that all components are present, and record relevant product information on *Information About Your System on page ii*.
2. Select an appropriate mounting location and orientation (see *Figure 6*). To meet regulatory requirements, for use in on-land applications, the Freedom XC must be mounted in one of the following orientations:
  - a. Under a horizontal surface (see A)
  - b. In a horizontal position on a vertical surface (see B)

**NOTE:** For marine installations, only this orientation is allowed, due to the probability of moisture finding access into the enclosure.
3. On a horizontal surface (see C)

Figure 6 Approved Mounting Orientations

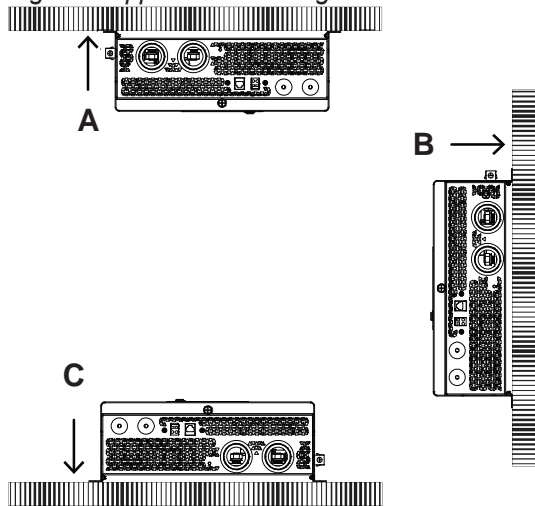

3. Mark the desired number of mounting holes on the wall by placing the unit on the wall.
4. Pilot-drill the mounting holes.
5. Fasten the Freedom XC to the mounting surface. If you are mounting the unit on a wall or bulkhead, use #12 or #14 pan-head wood or sheet metal screws to secure it to the framing behind the wall or bulkhead. Alternatively, use nut inserts and 1/4"-20 machine screws.

## Connecting the DC Equipment Ground

### **! WARNING**

#### **ELECTRIC SHOCK HAZARD**

Never operate the Freedom XC without properly connecting the DC equipment ground. A shock and energy hazard could result from improper grounding.

**Failure to follow these instructions can result in death, serious injury, or equipment damage.**

The Freedom XC has a ground lug on the side of the unit as shown in *Figure 7*. Follow the guidelines in *DC Grounding Locations* to connect the inverter/charger's chassis to the ground.

*Figure 7 DC Panel Connections*

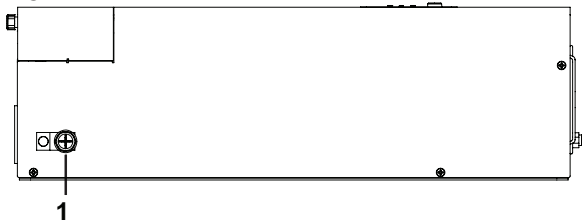

1	DC grounding lug
---	------------------

## DC Grounding Locations

You must connect the equipment DC ground lug to a grounding point—usually the vehicle's chassis or DC negative bus ground—using recommended copper wire size (if insulated then green insulation with or without one or more yellow stripes) or larger.

Make sure to tighten the bolt on the DC ground lug to a torque of 23 in-lb (2.6 N-m) of force. Apply an anti-corrosion compound to the copper wire prior to connecting to the DC ground lug.

For recommended equipment ground cable size, see below.

*Table 7 DC Equipment ground cable size*

<b>Application</b>	<b>Minimum equipment ground cable size (Stranded copper cable is required)</b>
Recreational Vehicle <sup>a</sup>	No. 8 AWG
Marine <sup>b</sup>	No. 3 AWG (Freedom XC 1000) No. 1/0 AWG (Freedom XC 2000)

**NOTE:** There are no restrictions on length for the equipment ground cable but try to make it as short as practical to a secure chassis connection.

<sup>a</sup>Based on US National Electrical Code NFPA70, Article 551, par. 551-20c and ANSI/RVIA LV, § 2-5.1.

<sup>b</sup>Based on ABYC E-11 § 11.16 and A-31 § 31.6.5.

## Step 4: Connecting the AC Input Wires

### WARNING

#### ELECTRIC SHOCK AND FIRE HAZARDS

Make sure wiring is disconnected from all electrical sources before handling. All wiring must be done in accordance with local and national electrical wiring codes. Do not connect the output terminals of the Freedom XC to any incoming AC source.

**Failure to follow these instructions can result in death, serious injury, or equipment damage.**

## General AC Wiring Considerations

### NOTICE

#### EQUIPMENT DAMAGE

Make sure the wires are connected properly. The AC wiring terminal blocks are split into input and output sections.

**Failure to follow these instructions can result in equipment damage.**

## AC Wiring Connectors

Where applicable, connect AC wires with crimp-on splice connectors. The amount of insulation you strip off individual wires will be specified by the connector manufacturer and is different for different types of connectors.

## AC and DC Wiring Separation

Do not mix AC and DC wiring in the same conduit or panel. Where DC and AC wires must cross, make sure they do so at 90° to one another. Consult applicable codes for details about DC and AC wiring in close proximity to each other.

## AC Wiring and GFCIs

You can plug loads of up to 20 amps directly into the GFCI receptacle on the front panel of the Freedom XC. If installed, you can also connect the inverter to an existing AC installation and then plug loads into GFCI receptacles connected to that circuit.

If you plan to use the Freedom XC GFCI kit on the unit, proceed to *GFCI Connections on page 1*.

AC wiring includes all the wires and connectors between the AC source and the Freedom XC and all wiring between the inverter/charger, the AC panels, GFCI, and circuit breakers. The type and size of the wiring varies with the installation and load. For some RV applications, flexible multiple-strand copper wire is required.

AC wiring must be sized appropriately using conductors with insulation rated at least 75 °C to carry full load current on the input and output AC circuits in accordance with the electrical codes or regulations applicable to your installation. *Table 8* is based on the U.S. National Electrical Code and the Canadian Electrical Code, assuming two-conductor-plus-ground cable, using 75 °C wiring, at an ambient temperature of 30 °C. Other codes and regulations may be applicable to your installation.

*Table 8 Required AC wire size vs. required breaker rating*

	<b>Required Breaker Size (A)</b>	<b>Required Wire Size (AWG)</b>
Freedom XC	30 A maximum 20 A maximum through a GFCI	10 AWG

When making the AC input and AC output connections, observe the correct color code for the appropriate AC wire, as described in *Table 9* below.

*Table 9 Color codes for typical AC wiring*

<b>Color</b>	<b>AC Wire</b>
Black/Red/Brown	Line
White/light blue	Neutral
Green, green/yellow, or bare copper	Ground

## ***NOTICE***

### **REVERSE POLARITY DAMAGE**

Make sure the wires are connected properly. Improper connections (connecting a line conductor to a neutral conductor, for example) will cause the Freedom XC to malfunction and may permanently damage the inverter/charger. Damage caused by a reverse polarity connection is not covered by your warranty.

**Failure to follow these instructions can result in equipment damage.**

### **Wiring Knockouts**

When installing wires to the AC terminals, the AC input and output holes are provided to accommodate ½" trade-size (approximately 13mm) strain relief clamps.



## AC Input Connections

To make a permanent connection to existing AC wiring:

1. Ensure AC and DC power sources are turned off.
2. Install the required circuit breaker in the AC distribution panel supplying AC power to the unit.
3. Remove the wiring compartment cover by loosening the captive nut panel screw and lifting the cover up and out.

### WARNING

#### ELECTRIC SHOCK HAZARD

Use a screwdriver to loosen the captive nut panel screw.

**Failure to follow these instructions can result in death, serious injury, or equipment damage.**

Figure 8 Loosening the captive nut panel screw

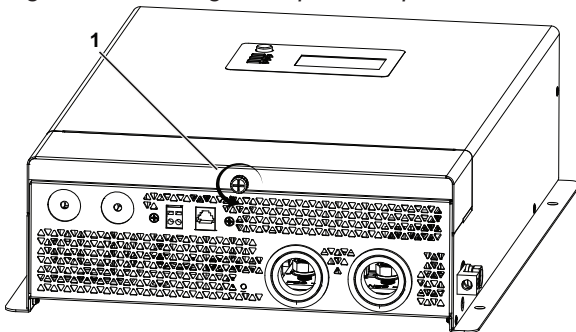

1 Captive nut panel screw

4. Strip a single AC input wire, as appropriate. Strip 11-13 mm off the ends of each of the three the wires (tin the exposed copper wire with lead-free solder using a soldering iron).
5. Install a 1/2" (or 3/4") strain relief clamp on the AC input hole.
6. Route the wires through the strain relief clamp (not shown in the figure).

Figure 9 Routing the AC input wires

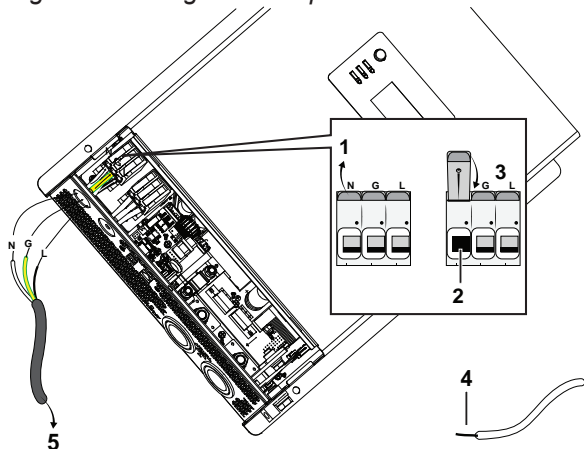

1	sub-step a on page 28
2	sub-step b on page 28
3	sub-step c on page 28
4	11-13 mm
5	to circuit breaker
<b>NOTE:</b> AC input hole - install a strain relief clamp (not shown).	

7. Locate the Neutral, Ground and Line terminals on the AC input terminal labeled as **N**, **G**, and **L** respectively.

8. Connect each AC wire into its corresponding terminal on the no-tool cage clamp terminal block.
  - a. Lift the terminal lever (as shown in the previous figure).
  - b. Insert the wire fully into the open slot.
  - c. Lower the terminal lever to secure the wire in the slot.
9. Make sure that each AC wire is matched and connected to the Neutral (**N**), Ground (**G**), and Line (**L**) connections.
10. Tighten the strain relief clamp to secure the wires.
11. Replace the wiring compartment cover onto the unit (using a #2 Phillips torque screwdriver - see WARNING), if you are not connecting other wires such as for the AC Output. Otherwise, keep the AC compartment open and proceed to the next step.

## **⚠ WARNING**

### **ELECTRICAL SHOCK HAZARD**

Use a torque screwdriver to tighten the captive nut panel screw to 5 in-lb (0.56 N-m) torque of force to ensure a proper ground connection and a required tool access to the wiring compartment.

**Failure to follow these instructions can result in death, serious injury, or equipment damage.**

12. Connect the other end of the wires to the circuit breaker in the AC distribution panel supplying AC power to the unit.

## Step 5: Connecting AC Output to an Existing AC Circuit

### **WARNING**

#### **ELECTRIC SHOCK AND FIRE HAZARDS**

- Make sure wiring is disconnected from all electrical sources before handling. All wiring must be done in accordance with local and national electrical wiring codes.
- A manufacturer-tested and approved GFCI must be connected to the Freedom XC AC output, and GFCI protection must be provided on every branch circuit feeding a receptacle connected to the AC hard wired installation. Other types may fail to operate properly when connected to the Freedom XC. See *Ground Fault Circuit Interrupters (GFCIs)* on page 20.

**Failure to follow these instructions can result in death, serious injury, or equipment damage.**

### ***NOTICE***

#### **EQUIPMENT DAMAGE**

- Do not connect any AC source (such as a generator or utility power) to the **AC output wiring** of the Freedom XC.
- The Freedom XC will not operate if its output is connected to AC voltage from a source, and potentially hazardous or damaging conditions may occur. These conditions can occur even if the inverter/charger is off.

**Failure to follow these instructions can result in equipment damage.**

Do not connect the Freedom XC to an AC branch circuit that has high-power consumption loads that exceed its output wattage rating.

The Freedom XC will not operate electric heaters, air conditioners, stoves, and other electrical appliances that consume more than its rated output wattage.

## AC Output Connections

Figure 10 Routing and connecting the AC output wires

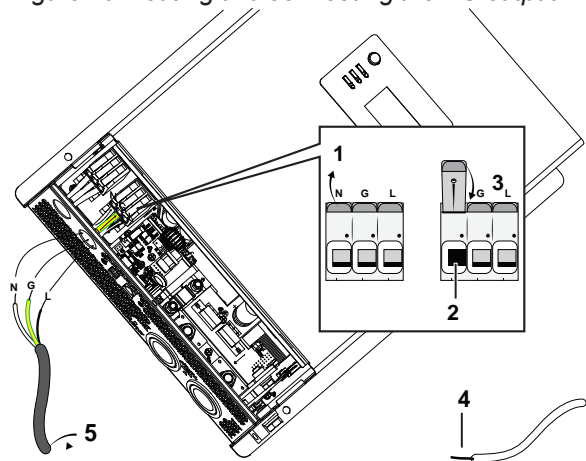

1	sub-step a on page 30
2	sub-step b on page 30
3	sub-step c on page 30
4	11-13 mm
5	to circuit breaker
<b>NOTE:</b> AC Output hole - install a bushing (supplied) or a strain-relief device.	

### To make a permanent connection to existing AC wiring:

1. Ensure AC and DC power sources are turned off, if not already done from *AC Output Connections on page 30*.

2. Install the required circuit breaker in the inverter/charger distribution panel receiving AC power from the inverter/charger.
3. Remove the wiring compartment cover, if not already done from *AC Output Connections on page 30*.

## **⚠ WARNING**

### **ELECTRIC SHOCK HAZARD**

Use a screwdriver to loosen the captive nut panel screw.

**Failure to follow these instructions can result in death, serious injury, or equipment damage.**

4. Strip a single AC output wire, as appropriate. Strip 11-13 mm off the ends of each of the three the wires (tin the exposed copper wire with lead-free solder using a soldering iron).
5. Remove the knockout and install a ½" strain relief clamp.
6. Route the wires through the strain relief clamp (not shown in the figure)
7. Connect each AC wire into its corresponding terminal on the no-tool cage clamp terminal block.
  - a. Lift the terminal lever (as shown on the figure).
  - b. Insert the wire fully into the open slot.
  - c. Lower the terminal lever to secure the wire in the slot.
8. Make sure that each AC wire is matched and connected to the Neutral (**N**), Ground (**G**), and Line (**L**) connections.

9. Tighten the strain relief clamp to secure the wires.
10. Replace the wiring compartment cover (using a #2 Phillips torque screwdriver - see WARNING), if you are finished with connecting all the AC wires in the unit.

## WARNING

### ELECTRICAL SHOCK HAZARD

Use a torque screwdriver to tighten the captive nut panel screw to 5 in-lb (0.56 N-m) torque of force to ensure a proper ground connection and a required tool access to the wiring compartment.

**Failure to follow these instructions can result in death, serious injury, or equipment damage.**

11. Connect the other end of the wires to a circuit breaker in AC distribution panel providing AC power to the loads.

## Step 6: Connecting the DC Cables

### NOTICE

#### REVERSE POLARITY

- Check cable polarity at both the battery and the Freedom XC before making the final DC connection. Positive must be connected to positive; negative must be connected to negative. Check to see if the reverse polarity LED (see *Step 6: Connecting the DC Cables*) is not illuminated.
- Reversing the positive and negative battery cables will blow a fuse in the Freedom XC and void your warranty.

**Failure to follow these instructions can result in equipment damage.**

## WARNING

#### FIRE HAZARD

Use only stranded, copper wire rated minimum 90 °C (105 °C for marine installations). Make sure all DC connections are tight to a torque of 71–89 in-lb (8–10 Nm) of force. Loose connections will overheat.

**Failure to follow these instructions can result in death, serious injury, or equipment damage.**

Follow the procedure given below to connect the battery leads to the terminals on the DC end. The cables should be as short as possible and large enough to handle the required current, in accordance with the electrical codes or regulations applicable to your installation. *Table 6* specifies the minimum DC cable size and maximum fuse size for the Freedom XC.

If at all possible, minimize routing your DC cables through an electrical distribution panel, battery isolator, or other device that will cause additional voltage drops which can degrade the inverter/charger's ability to operate the loads.

### To make the DC connections:

1. Make sure the inverter/charger is off and no AC or DC is connected to the unit.
2. Remove the wiring compartment cover by loosening the captive nut panel screw.

## WARNING

### ELECTRIC SHOCK HAZARD

Use a screwdriver to loosen the captive nut panel screw.

**Failure to follow these instructions can result in death, serious injury, or equipment damage.**

3. Loosen the DC terminal nuts from the terminal bolts and set them aside for later.
4. Strip  $\frac{1}{2}$ " (13 mm) to  $\frac{3}{4}$ " (19 mm) insulation from one end of each cable. The amount stripped off will depend on the terminals chosen.
5. Attach the connectors that will secure the cables to the battery, to the disconnect/battery selector switch, and the fuse block. The connectors you use must create a permanent, low-resistance connection. It is recommended to use approved and certified cable ring lugs. Use the tool recommended by the terminal manufacturer. Make sure no stray wires protrude from the lug or terminal.  
**NOTE:** You may find it more convenient to have the cable lugs attached by the company that sells you the cable and/or connectors.

6. Strip  $\frac{1}{2}$ " (13 mm) to  $\frac{3}{4}$ " (19 mm) of insulation from each cable end that will be connected to the inverter/charger. The amount stripped off will depend on the terminals chosen.
7. Attach the cable ring lug that will join the cable to the inverter/charger DC terminal. Cover the lug stem with heat shrink insulation (see *Step 6: Connecting the DC Cables*) to ensure that the lug does not touch the enclosure.
8. Install a fuse and fuse holder in the cable that will be used for the positive side of the DC circuit. The fuse must:
  - a. be as close to the battery positive terminal as possible
  - b. be rated for DC circuits
  - c. have an Ampere Interrupting Capacity (AIC) that exceeds the short-circuit current available from the battery (that is, Class T fuse)
9. To prevent sparking when making the connection, ensure the disconnect/battery selector switch is off.
10. Route the positive cable through the left side strain relief clamp and attach the cable lug on the positive cable to the positive DC terminal on the inverter/charger.
11. Fasten the DC terminal nut (set aside earlier) to the terminal bolt. Tighten the nut to a torque of 71–89 in-lb (8–10 N-m) of force. Do not overtighten. Make the connection snug enough so the cable lug does not move around on the DC terminal. Center it through the DC knockout hole and do not let it touch the edge. See *Step 6: Connecting the DC Cables on page 31*.

## WARNING

### ELECTRICAL SHOCK HAZARD

- Tighten the nuts on the DC terminals properly. Loose connections cause excessive voltage drop and may cause overheated wires and melted insulation.
- Do not over-tighten the nut on the DC input terminals because damage to the DC input terminals may result. Use a torque screwdriver to tighten the nut to a maximum torque of 89 in-lb (10 N-m) of force.

**Failure to follow these instructions can result in death, serious injury, or equipment damage.**

## NOTICE

### REVERSE POLARITY

- Check cable polarity at both the battery and the Freedom XC before making the final DC connection. Positive must be connected to positive; negative must be connected to negative. Check to see if the reverse polarity LED (see *Step 6: Connecting the DC Cables*) is not illuminated.
- Reversing the positive and negative battery cables will blow a fuse in the Freedom XC and void your warranty.

**Failure to follow these instructions can result in equipment damage.**

Figure 11 DC Cable Connections

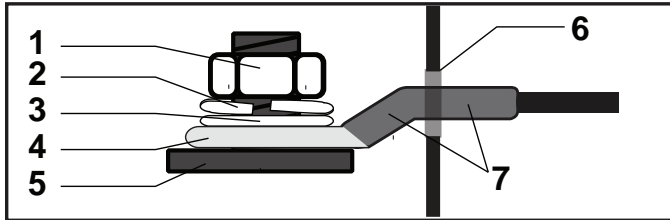

1	DC terminal bolt nut
2	lock washer
3	flat washer
4	cable ring lug
5	DC terminal
6	DC knockout hole
7	DC cable with heat shrink insulation covering the lug stem
<b>NOTE:</b> The DC cable lug stem must be fully insulated with the heat shrink.	

- Before proceeding, double check that the cable you have just installed connects the positive DC terminal of the inverter/charger to the disconnect/battery selector switch, fuse holder, and that the other end of the fuse holder is connected to the positive terminal of the battery.

## **⚠ WARNING**

### **FIRE HAZARD**

Do not complete the next step if flammable fumes are present. Explosion or fire may result if the disconnect/battery selector switch is not in the off position. Thoroughly ventilate the battery compartment before making this connection.

**Failure to follow these instructions can result in death, serious injury, or equipment damage.**

- Route the negative cable through the right side strain relief clamp and connect the cable from the negative post of the battery to the negative DC terminal of the inverter/charger.
- Fasten the DC terminal nut (set aside earlier) to the terminal bolt. Tighten the nut to a torque of 71–89 in-lb (8–10 N-m ) of force. Do not overtighten. Make the connection snug enough so the cable lug does not move around on the DC terminal. Center it through the DC knockout hole and do not let it touch the edge.



15. Replace the wiring compartment cover by tightening the captive nut panel screw. See the following electrical shock hazard warning.

## WARNING

### ELECTRICAL SHOCK HAZARD

Use a torque screwdriver to tighten the captive nut panel screw to 5 in-lb (0.56 N-m) torque of force to ensure a proper ground connection and a required tool access to the wiring compartment.

**Failure to follow these instructions can result in death, serious injury, or equipment damage.**

## DC Equipment Grounding

To connect the DC equipment ground:

1. The DC equipment grounding lug (DC ground lug) on the DC end of the Freedom XC is used to connect the chassis of the Freedom XC to your system's DC negative connection or grounding bus point as required by electrical regulations.
2. Use copper wire that is either bare or provided with green insulation. Do not use the DC ground lug for your AC grounding. See the AC wiring instructions in this section.
3. Follow the guidelines below that correspond to the specific type of installation. These guidelines assume you are using the DC supply cable and fuse sizes recommended in this guide. If you are using different sizes, refer to the applicable installation code for DC grounding details.
4. See *Figure 7 on page 24* for the location of the DC ground lug. Make sure to tighten the bolt on the DC ground lug to a torque of 23 in-lb (2.6 N-m) of force. Apply an anti-corrosion compound to the copper wire prior to connecting to the DC ground lug.

## Recreational Vehicle

Use 8AWG minimum-sized, stranded copper wire and connect it between the Chassis Ground lug and the vehicle's DC grounding point (usually the vehicle chassis or a dedicated DC ground bus). See regulatory references below.

## Marine

Use stranded copper wire that is bare or has insulation rated minimum 105 °C, and connect it between the Chassis Ground lug and the boat's DC grounding bus or engine negative bus. For the Freedom XC 1000, use a wire of gauge 3AWG minimum. For the Freedom XC 2000, use a wire of gauge 1/0AWG minimum. See regulatory references below.

### Regulatory references

For DC voltage systems 60 VDC or less in an RV installation, an 8AWG copper bonding conductor would be acceptable for the inverter/charger enclosure ground bonding only per UL458 §63.6; §30.10 standard [≤ 150 mV @ 30A connection, per §63.9; §63.10] and per ANSI/RVIA LV code §2-5.1 Bonding Voltage Converter Enclosures. The "house" battery system must, however, be ground bonded per ANSI/RVIA LV code §2-4 Auxiliary Battery Grounding; and  
For DC voltage systems 60 VDC or less in a marine installation, [UL458 §SA7.2] a DC Grounding conductor shall not be smaller than one size under that required for current carrying conductors supplying the device per ABYC E-11 §11.16.2 but not less than 8AWG [USGC 46 CFR §111.05-31].

## Step 7: Connecting to Port(s) on the Freedom XC

### Connecting to ACC Signal

The Freedom XC can be wired to inhibit inverter operation in the absence of a vehicle's (or vessel's) ignition control signal. This feature can avoid unnecessary battery drain that would otherwise occur if the inverter was operated without a charging source such as the vehicle alternator.

1. Ensure that AC and DC power are both OFF.
2. Ensure the vehicle's ignition is turned to OFF position. It is highly recommended to remove battery power by disconnecting the vehicle's battery cables. Refer to the vehicle's user manual for proper instructions on how to disconnect the battery cables.
3. Locate the vehicle's ignition control wire from the vehicle's ignition circuit. This wire must be fused appropriately at no more than 5 A. Refer to the vehicle's user manual for guidance.
4. Locate the ACC input (ignition signal input) terminal on the right side of the connector. The left terminal is not used at this time. See *Figure 12*

*Figure 12 Ignition signal (ACC) input terminal*

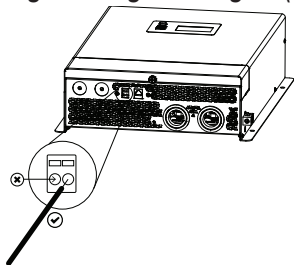

### Description of Ignition Control Features

For information about the features and instructions on changing the ignition control features, see *Operation on page 43*.

*Table 10 Ignition Control Features*

<b>Ignition Auto-on (AEO)</b>	This setting allows the inverter/charger to operate (Battery mode) automatically when an ignition control wire is connected to the ACC input and a valid ignition signal is constantly detected. The inverter works in tandem with the vehicle's ignition circuit.
<b>Ignition Lock-out (LOI)</b>	This setting allows the inverter to operate (Battery mode) when an ignition control wire is connected to the ACC input terminal and a valid ignition signal is constantly detected.  When enabled, you have to manually press the Power button on the display panel to operate the inverter.
<b>Off (OFF)</b>	To completely disable the ignition control features do the following: Set Ignition Control to Off (OFF) using the Select buttons on the Display panel.

## Connecting to the Remote Port

To connect the remote panel to the remote port:

- Plug the remote panel unit's cable connector to the RJ12 Remote port on the unit.

**NOTE:** When the remote panel is connected, turn the inverter/charger's Power button to Standby (up position). This allows the remote panel to control the inverter/charger's power status.

## Step 8: Testing Your Installation

### **WARNING**

#### **ELECTRIC SHOCK HAZARD**

Pressing the Power button to turn the Freedom XC inverter to Standby on the display panel does not disconnect DC or AC input power to the Freedom XC. If shore power is present at AC input terminals, it will pass through to the AC output.

**Failure to follow these instructions can result in death, serious injury, or equipment damage.**

There are two tests to be performed. The first test verifies that the Freedom XC is inverting DC battery power and delivering AC power to its output.

The second test is intended for installations where AC input and output is hard wired to the Freedom XC. This test verifies that the Freedom XC transfers from inverter power to shore power when shore power is present.

**NOTE:** Shore power (pass-through) refers to the AC input power from a utility grid, generator or external AC source.

When you are ready to test your installation and operate the Freedom XC, close the DC fuse and Disconnect or the DC circuit breaker to supply DC power to the Freedom XC.

## Testing in Battery Mode

### To test the Freedom XC:

1. For hard wired installations, ensure shore power is not present.
2. Press the Power button to turn the inverter/charger on. The green LED indicating Battery mode (Inverter mode) turns on and the LCD screen displays the **BATT. MODE** icon.
3. Connect a test load, such as a lamp within the power rating of the inverter/charger into the Freedom XC GFCI or an AC outlet hard wired to the Freedom XC.
4. Turn the lamp on to verify that it operates.

If the lamp operates, your installation is successful. If your installation has AC input and output hard wired to the Freedom XC, proceed to *Testing in Grid Mode*.

If the status LED on the display panel glows red, see the Troubleshooting chapter.

## Testing in Grid Mode

### To test the Freedom XC:

- With the test load from the previous test still connected and operating, connect the shore power source.
- The Freedom XC transfers the test load to shore power. The green LED indicating grid mode turns on and the LCD screen displays the **AC MODE** icon.
- If the test load operates, your installation is successful.

**NOTE:** If the Power button on the Freedom XC is turned ON, the Freedom XC will automatically supply the appliances with inverter power if the shore power source fails or becomes disconnected.

If the Power button on the Freedom XC is turned ON and shore power voltage is too low (less than 90 volts AC), the unit will transfer to inverter power to continue running your appliances.

**NOTE:** Whether or not the Power button is turned ON, shore power will pass through the Freedom XC to the output when shore power is within normal operating range. The unit also starts charging the battery after the transfer to grid mode.

**NOTE:** In the event of low or no battery voltage, shore power will pass through the Freedom XC to the output even when shore power is outside the normal operating range.



# Marine Installation

Figure 13 illustrates a typical marine installation with the following components:

1	DC Equipment ground – Engine negative bus / DC ground bus
2	Freedom XC
3	DC fuse/disconnect/DC circuit breaker
4	12V deep cycle battery [house]
5	Battery isolator
6	DC alternator
7	To engine
8	DC Equipment ground – Engine negative bus / DC ground bus
9	Starting battery
10	AC load panel with branch circuit breakers that supply only loads that run off the Freedom XC
11	AC source panel that includes a max 30A (or a 15A if using a GFCI) circuit breaker that supplies the Freedom XC <b>IMPORTANT</b> To the installer: Affix the provided safety label to the source panel where the Freedom XC will be connected to.
12	Shore power – AC power supplied from a shore power connector
Not shown	Drip shield (see next page)

Figure 13 Typical Marine Installation

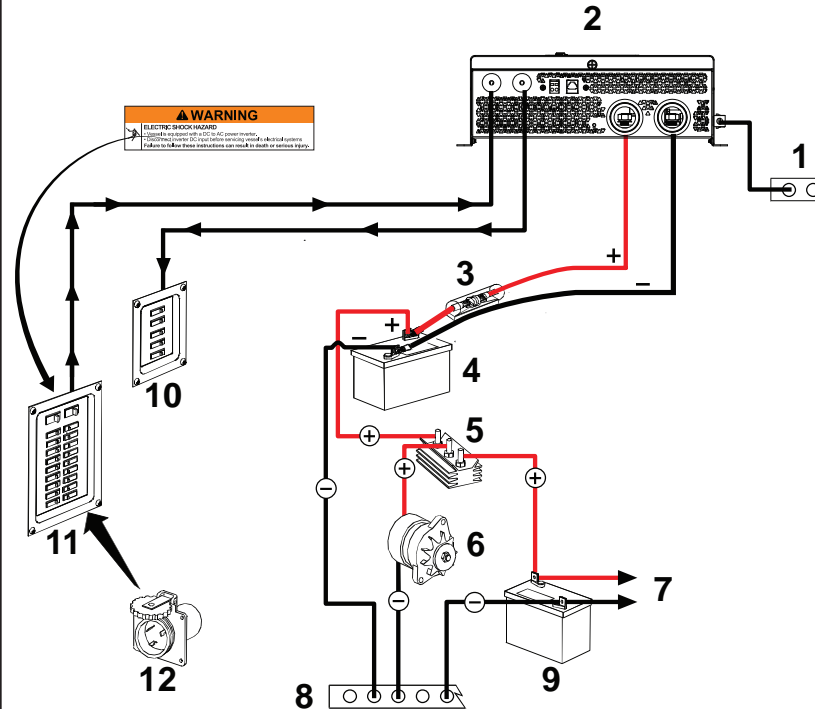

## Drip Shield Installation

The drip shields help to protect the unit from dripping or splashing liquids, which will cause a shock hazard when moisture comes in contact with electrical circuits in the unit. The drip shields are especially useful in marine installations where water from condensation, rain, or sea may come into contact with the Freedom XC.

### **⚠ WARNING**

#### **ELECTRICAL SHOCK HAZARD**

Place this unit in normally dry areas only. Operating the unit under wet conditions may expose you to a shock hazard. Installing drip shields may not entirely protect you from this hazard. Do not operate the unit when it is wet.

**Failure to follow these instructions can result in death, serious injury, or equipment damage.**

You may purchase the drip shield set by contacting customer support. When ordering, mention part number 808-1050.

*Figure 14 Drip shields*

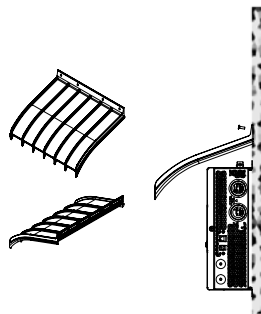

#### **To install the drip shields:**

1. Gather the four screws needed to fasten a single drip shield to a wall.
2. Locate an appropriate setting for the drip shields above the Freedom XC making sure you cover the entire width of the unit. You can overlay the shields as shown in *Figure 15*.
3. Fasten the screws through the holes in the drip shield into the wall. See *Figure 14*.

*Figure 15 Typical Drip Shield Placement on a Freedom XC*

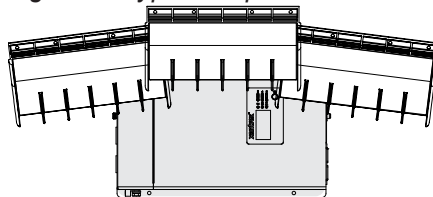



## 4 OPERATION



This section includes descriptions of the different modes and settings of the Freedom XC Inverter Charger. This section includes:

<b>Freedom XC Display Panel</b> .....	<b>44</b>	Operating Several Loads at Once .....	59
Status LED Indicators .....	44	Turning the Audible Alarm ON or OFF .....	60
Function Buttons .....	45	<b>Operating in Grid Mode</b> .....	<b>61</b>
LCD Screen .....	45	Battery Charger Functions .....	61
LCD Screen Icons .....	46	Battery Types .....	61
<b>Viewing Information During Battery Mode</b> .....	<b>47</b>	Custom Battery Settings Menu .....	65
Viewing Information During Grid Mode .....	49	<b>Operating During Transition Between Grid Mode and Battery Mode</b> .....	<b>65</b>
<b>Adjusting Settings in Configuration Mode</b> .....	<b>51</b>	Transitioning from Grid Mode to Battery Mode .....	66
Settings .....	53	Transitioning from Battery Mode to Grid Mode .....	66
<b>Operating in Battery Mode</b> .....	<b>58</b>	<b>Operating Limits</b> .....	<b>66</b>
Turning Inverter Operation ON .....	58	Power Output .....	67
Power Save Timer .....	59	Input Voltage .....	67
Power Save Mode .....	59	Overload Conditions .....	69
Checking Battery Status .....	59	High Surge Loads .....	69
Checking Output Power .....	59	Over-temperature Conditions .....	69

# Freedom XC Display Panel

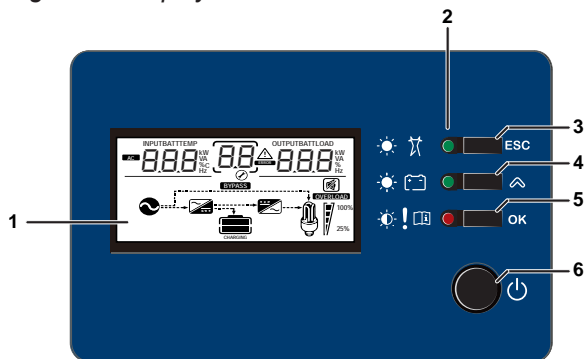











Figure 16 Display Panel







1	LCD screen
2	Status LED indicators
3	<b>ESC</b> see "Function Buttons" on the facing page
4	 see "Function Buttons" on the facing page
5	<b>OK</b> see "Function Buttons" on the facing page
6	 see "Function Buttons" on the facing page

**NOTE:** Briefly pressing any function button activates backlight illumination. After 60 seconds of inactivity, backlight illumination turns off.

## Status LED Indicators

Indicator	Definition
 ←  	Solid green. Indicates grid mode in which shore power is available and passing through to the loads and charging the battery.
  ← 	Solid green. Indicates Battery mode (Inverter mode) in which the inverter/charger is running and supplying power to the loads from the battery.
   ←	Solid red. Indicates error or fault mode and is accompanied by an error code displayed on the LCD screen. For a list of error codes, see <i>Motor Loads on page 82</i> .
   ←	Flashing red. Indicates a Warning condition and is accompanied by an error code and a sounding alarm. For a list of error codes, see <i>Motor Loads on page 82</i> .

## Function Buttons

Button	Definition
	Return to default screen or exit setting mode.
	Scroll to next screen or next selection. Press and hold for three seconds to scroll back one step.
	To enter the Configuration mode or to confirm the setting.
	Turns on inverter/charger operation or to Standby.

## LCD Screen





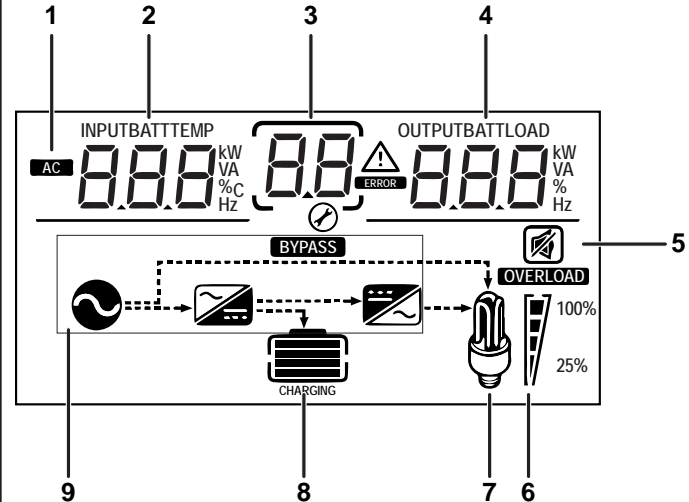

The LCD Screen changes depending on the operating mode of the inverter/charger.







Figure 17 Parts of the LCD Screen



1	AC IN or AC OUT indicator	6	load power level indicator
2	left part of LCD display	7	load indicator
3	middle part of LCD display	8	battery level indicator
4	right part of LCD display	9	mode indicator
5	alarm off indicator		

## LCD Screen Icons

Icon	Definition
	AC input and output indicator.
	The wrench icon underneath a number is displayed during configuration mode.
	An error event with its corresponding number is displayed here.
	A warning event with its corresponding number is displayed here.
	The charging indicator is displayed when the unit is in charger mode.
	The battery icon indicates remaining battery power. One bar = 1-25%, two bars = 25-50%, three bars = 50-75%, and four bars = 75-100%.
	Shows an overload condition.

Icon	Definition
	The load icon is displayed if there is voltage available at the AC output.
	The bar represents load consumption levels. 100% is an indication of full capacity and 25% indicates low consumption. All the bars disappear at < 20 watts, and AC load indicates zero watt power.
	Shows up in grid mode when AC shore power is present. If the power is being qualified, then this icon will flash.
	Shows that the unit is in grid mode and is bypassing shore power directly to the loads.
	This icon shows when there is power conversion from AC to DC - charging.
	This icon shows when there is power conversion from DC to AC - inverting.
	The alarm buzzer is muted.

# Viewing Information During Battery Mode

The LCD screen displays information related to battery mode operation.

- Press the Scroll  button to move from screen to screen.  
Press and hold for three seconds to go back one step.

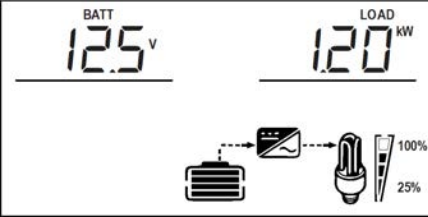
Info and Setting	LCD Screen
Screen 1 of 4 - Battery Voltage/Load Wattage  This is the home screen.	 <p>battery voltage = 12.5V, AC load = 1.2kW</p>

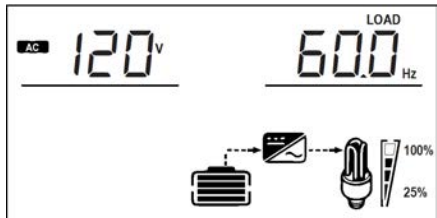
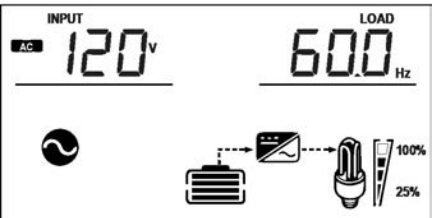
Info and Setting	LCD Screen
Screen 2 of 4 - AC Output Voltage/Frequency	 <p>output voltage = 120V, output frequency = 60Hz</p>
Screen 3 of 4 - AC Input Voltage/Frequency  Screen shows up when utility AC is connected.	 <p>input voltage = 120V, input frequency = 60Hz</p>

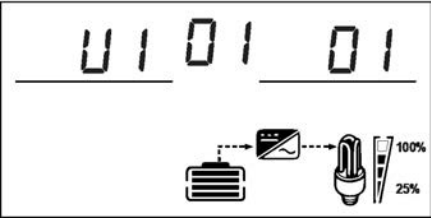
Info and Setting	LCD Screen
Screen 4 of 4 - Firmware version	 <p>The LCD screen displays the firmware version 'U1 01 01' in a large, segmented font. Below the version, there are several icons: a battery pack, a power button, a light bulb, and a battery level indicator showing 100% and 25%.</p>
	Firmware version = U1 1.01

# Viewing Information During Grid Mode

- 1. The LCD screen displays information related to AC bypass or charger operation.
- 2. Press the Scroll  button to move from screen to screen.
- 3. Press **ESC** to return to the home screen.

**NOTE:** After one minute of inactivity in the other screens, the LCD will go back to the home screen.

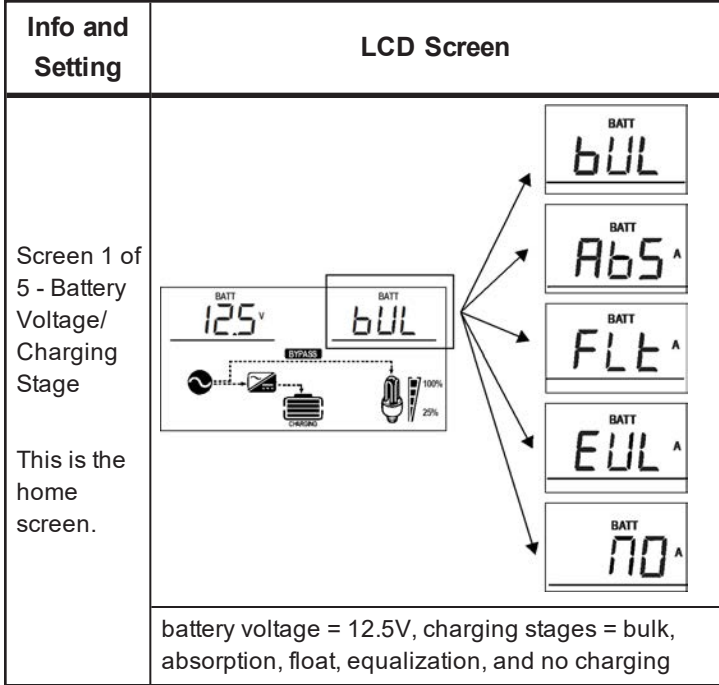

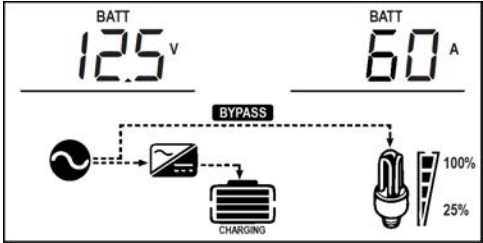
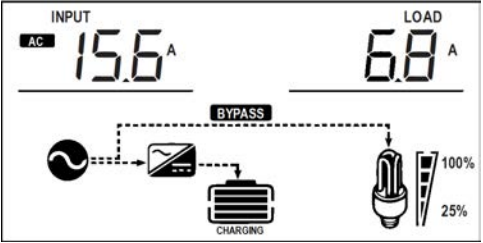
Info and Setting	LCD Screen
Screen 2 of 5 - Battery Voltage/ Charging Current	 <p data-bbox="203 455 716 483">battery voltage = 12.5V, charging current = 60A</p>
Screen 3 of 5 - AC input current/AC load current	 <p data-bbox="203 769 651 796">input current = 15.6A, load current = 6.8A</p>

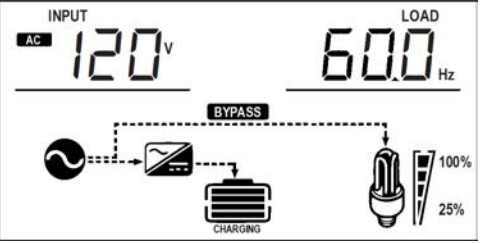
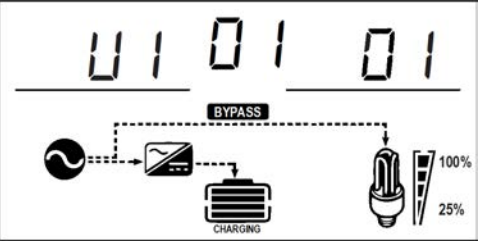
Info and Setting	LCD Screen
Screen 4 of 5 - AC input voltage/AC input frequency	 <p data-bbox="980 455 1477 483">input voltage = 120V, input frequency = 60Hz</p>
Screen 5 of 5 - Firmware version	 <p data-bbox="980 774 1282 802">Firmware version = U1 1.01</p>



# Adjusting Settings in Configuration Mode

The **OK**, Scroll , and **ESC** buttons can be used to cycle through the various settings:

1. Press and hold the **OK** button for three seconds to enter Configuration mode and change general settings. Press the **OK** button to enter sub-settings, if applicable.
2. Press the Scroll  button to scroll through the different settings. Press and hold for three seconds to scroll back one step.

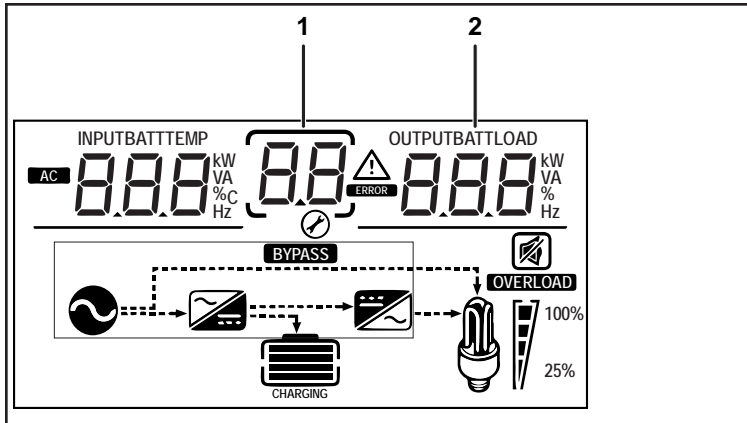

1	setting number is displayed here
2	setting value is displayed here



To change the default value to a different value and to save the change permanently:

## NOTICE

### REQUIRED OPERATION

- You must **ALWAYS** perform the steps under *IMPORTANT STEPS on page 52* in order to save any configuration changes permanently.
- In some circumstances when you need to immediately disconnect the Freedom XC from AC and DC power sources, be sure to turn off the Freedom XC using the Power button (see *Turning Inverter Operation ON on page 58*) prior to disconnection so that the configuration changes are saved.

**Failure to follow these instructions can result in equipment damage due to lost configuration changes.**

1. Press and hold the **OK** button for three seconds to enter the Configuration mode.
2. Press the Scroll  button to scroll through the different settings. Press and hold for three seconds to scroll back one step.
3. Press the **OK** button to select a general setting and change its value. Also press, to select a sub-setting, if applicable.
4. Press the Scroll  button to change the value until you reach the desired value. Press and hold for three seconds to scroll back one step.

5. Press the **OK** button to confirm the change.
6. Repeat the previous steps to set other settings.
7. Press the **ESC** button to exit the Configuration mode.

---

### **IMPORTANT STEPS**

8. Keep the Freedom XC powered with a DC source (battery).
  9. Remove any AC source. Open the AC circuit breaker feeding AC power to the Freedom XC.
  10. Turn off the Freedom XC using the Power button on the unit. If the Remote Display panel is also connected to the unit, you must use the Power button on the remote panel to turn off the Freedom XC. See *Turning Inverter Operation ON on page 58*.
-

## Settings

Setting Name	Setting Number	Default Value	Range of Values	Description
Inverter Ignition Control	01	OFF	OFF LOt AtD	See <i>Description of Ignition Control Features on page 37</i> .
LBCO Voltage	02	10.5	10.0 to 12.8	The voltage setting value can be adjusted by 0.1 increments. The inverter is able to recover automatically at LBCO voltage + 0.2 volts.
LBCO Shutdown Delay Timer	03	300	1 to 300	When the range is from 1 to 20, the timer setting value can be adjusted by 1-second increments. When the range is from 20 to 300, the timer setting value can be adjusted by 10-second increments.
LBCO Recovery Voltage	04	13.1	12.0 to 16.0 and OFF	The range is from LBCO voltage + 0.2 to 16, adjusted by 0.1 increments. Selecting OFF or a higher value than the battery's actual fully-charged voltage level will disable the auto-recovery feature. You may manually reset the inverter/charger when the low battery cut off event occurs.

Setting Name	Setting Number	Default Value	Range of Values	Description
LBCO Recovery Voltage	04	13.1	10.2 to 16.0 and OFF	The range is from LBCO voltage + 0.2 to 16, adjusted by 0.1 increments. Selecting OFF or a higher value than the battery's actual fully-charged voltage level will disable the auto-recovery feature. You may manually reset the inverter/charger when the low battery cut off event occurs.
Power Save Time	05	25	OFF, 1 to 25	The range is from 1 to 25, adjusted by 1-h increments. The next setting after 25 is OFF.
Power Save (Load Sensing) Mode	06	d1 5	EnA (enable), d1 5 (disable)	When enabled, the inverter/charger's "no load" loss can be reduced further when total load is less than 25 W.
Output Frequency	07	60	60 50	After changing the output frequency setting, turn the unit off and then on again, in order for the change to take effect.
Output Voltage	08	120	120 110 108	
Inverter Output Power Limit (Freedom XC 1000)	09	1.0	0.1 to 1.0	The wattage setting value can be adjusted by 100-watt increments. Use with Inverter Output Power Limit Timer especially when pairing with a lithium ion battery. 0.1 is equivalent to 100 watts.
Inverter Output Power Limit (Freedom XC 2000)	09	2.0	0.1 to 2.0	

Setting Name	Setting Number	Default Value	Range of Values	Description
Inverter Output Power Limit Timer	10	300	1 to 300	When the range is from 1 to 20, the timer setting value can be adjusted by 1-second increments. When the range is from 20 to 300, the timer setting value can be adjusted by 10-second increments. Use with Inverter Output Power especially when pairing with a lithium ion battery. The timer is automatically disabled if the maximum Inverter Output Power limit is selected.
Transfer Mode	11	A <sub>PL</sub>	A <sub>PL</sub> (appliance) U <sub>PS</sub> (UPS)	Selecting A <sub>PL</sub> - appliance sets the transfer time from line to battery to 20 ms. Selecting U <sub>PS</sub> (uninterruptible power supply) sets the transfer time from line to battery to 10 ms. <b>NOTE:</b> Do not connect motor loads when in UPS transfer mode. See <i>Troubleshooting on page 73</i> .
Utility AC Under Voltage Level	12	90	85 to 110	
Inverter Shutdown Recovery	13	↱A <sub>E</sub>	A <sub>E</sub> (auto-restart) ↱A <sub>E</sub> (manual restart)	The inverter shuts down when there is an over temperature, overload, and short circuit condition. Selecting A <sub>E</sub> (auto-restart) will allow the inverter/charger to recover automatically from a shutdown up to three times maximum. Selecting ↱A <sub>E</sub> (manual restart) allows the user to restart the inverter/charger by performing a manual reset, that is, by acknowledging the restart via the display panel.

Setting Name	Setting Number	Default Value	Range of Values	Description
Audible Alarm	14	b0n	b0n (Audible) b0F (Mute)	The alarm beeps once every 5 s.
Battery Type	20	FLd	FLd (Flooded), AGi (AGM), 9EL Gel USE (Custom) LFP (LiFePO <sub>4</sub> )	See <i>Important Safety Instructions on page v</i> for safety warning instructions.
Battery Temperature	21	H0t	CLd (Cold) ur.i (Warm) H0t (Hot)	Selecting Cold from Warm will increase charger voltage by 0.4V. Selecting Cold from Hot will increase charger voltage by 0.8V.
Custom Absorption Voltage	22	14.6	12.0 to 18.0	The voltage setting value can be adjusted by 0.1 increments. Available only when custom battery type is selected.
Custom Float Voltage	23	13.5	12.0 to 18.0	
Charger Current (Freedom XC 1000)	24	50	5 to 50	The current setting value can be adjusted by 5A increments.
Charger Current (Freedom XC 2000)	24	80	5 to 80	
Charger Ignition Control	25	OFF	OFF (OFF) Rt0 (Auto-ON)	See <i>Description of Ignition Control Features on page 37</i> .

Setting Name	Setting Number	Default Value	Range of Values	Description
Equalize Charging for Flooded Battery	27	dI 5	EnA (enable) dI 5 (disable)	This setting is only available when Flooded battery type is selected. It allows only one hour of equalize charging once.
AC Input Breaker for Load Share	28	30	5 to 30	The load share feature prioritizes the AC load by reducing the charge current in order to maintain the total input current to less than the load share setting.
Reset all settings to their default values	99	ndF	ndF (as is) dEF (default)	ndF refers to current settings. Choose dEF to restore all settings to their default values.

## Operating in Battery Mode

The Freedom XC is in Battery Mode (also called Inverter Mode) when all the following conditions exist:

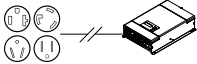
- inverter power button is ON  (down position) or ignition auto-on is activated
- shore power is not presently available 
- battery has sufficient power

Inverter operation means that DC battery power is presently being converted to utility grade AC power, powering equipment and appliances connected to the AC output terminal of the unit. The green status LED lights up to indicate the Freedom XC is using the battery to power the equipment and appliances.

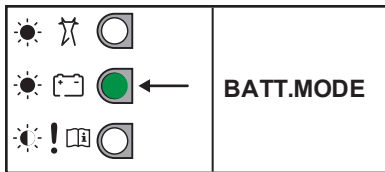

## Turning Inverter Operation ON

There are two ways to operate the Freedom XC's inverter function.

1. Press the Power button to a down position (it is in Standby in the up position).
2. When the inverter/charger's Ignition Control feature is set to Auto-on (A-E ), a +12VDC signal is present on the ACC input<sup>b</sup>.

### WARNING

#### ELECTRICAL SHOCK HAZARD

Turning the Power  button to Standby does not disconnect DC battery power from the Freedom XC. You must disconnect from all power sources before working on any circuits connected to the unit.

**Failure to follow these instructions can result in death, serious injury, or equipment damage.**

To prevent unnecessary battery discharge, press the Power button to Standby when you are not using the Freedom XC.

<sup>a</sup>See *Adjusting Settings in Configuration Mode* on page 51.

<sup>b</sup>When the vehicle's ignition switch is On or the vehicle's engine is running.



## Power Save Timer

The Power Save Timer is an adjustable countdown timer from 1 to 25 h (25 h is the default) that automatically shuts down inverter operation to reduce battery discharge and preserve battery life. During continuous inverter operation, the countdown is initiated when power from the AC load drops to less than approximately 50 W and remains below this level. After reaching the end of the countdown timer the inverter/charger automatically shuts down.

To change the countdown timer, see *Settings on page 1*.

## Power Save Mode

By enabling the power save mode, also called load sensing, the inverter/charger can automatically go to power save mode by sending short pulses to further reduce the battery discharge. Power save mode ends when a load greater than 25 W is connected.

**NOTE:** Certain types of loads can cause power save mode to work unexpectedly. These types of loads are described in *Problem Loads on page 83*.

## Checking Battery Status

During inverter operation (in battery mode), you can check the battery status by observing the battery capacity indicator on the LCD screen. The battery voltage appears in the left side of LCD screen.

The normal operating battery voltage range is between 11 and 15 volts.

## Checking Output Power

When the inverter/charger is in operation (in battery mode), you can check how much power (displayed in kW) the Freedom XC is supplying to the connected loads by observing the load capacity indicator on the LCD screen. The battery discharge amperage appears in the right side of the LCD screen.

## Operating Several Loads at Once

If you are going to operate several loads from the Freedom XC, turn them on one at a time after you have turned the inverter/charger on.

Turning loads on separately helps to ensure that the inverter/charger does not have to deliver the starting current for all the loads at once, and will help prevent an overload shutdown.

## Turning the Audible Alarm ON or OFF

The Freedom XC's audible alarm can be muted. See *Adjusting Settings in Configuration Mode on page 51*.

Any warnings such as error or fault conditions or imminent shutdown are both displayed on the LCD screen and sounded on the alarm speakers. See *To manually reset the alarm: on page 60*.

Audible alarm for warning: The unit beeps once when a warning condition is detected.

Audible alarm for error: The unit beeps once every 5 s for 1 min.

### To mute the alarm:

- Press any one of the three function buttons.

The alarm is automatically muted after 1 min. But the error code continues to be displayed until the error is cleared.

### To manually reset the alarm:

1. Press the Power button to turn it to Standby (from a down position to up) and press again to turn it On to reset an active alarm and clear the error.
2. If the Inverter Ignition Control is set to auto-on, toggle the ignition signal to clear the alarm and error.
3. Toggle the AC input power to force the transition between grid mode and battery mode. This action clears the alarm and error.

# Operating in Grid Mode

## Battery Charger Functions

When AC power is available, the Freedom XC can operate as a 12-V $\overline{=}$  battery charger. Different battery types and chemistries require different charging voltage levels. Not charging batteries at the required levels can shorten battery life or damage the batteries. The Freedom XC is configured at the factory to work with the battery types recommended for inverter applications. If the default settings do not work for your specific installation, you can adjust the charge stage settings (as recommended by the battery manufacturer) on the Custom (Battery) Settings menu (see *Custom Battery Settings Menu on page 65*).

**NOTE:** This information is provided for guidance only. Variations in battery chemistry and site-specific environmental considerations mean that you should consult your system designer or battery manufacturer for specific recommendations for appropriate battery voltage and current settings.

## Battery Types

The Freedom XC Inverter Charger charges flooded (or wet) lead-acid, Gel, AGM (absorbed glass mat), custom, and lithium iron phosphate (LFP) Xantrex batteries.

- Flooded (or wet) batteries have removable battery caps for refilling with distilled water and testing the electrolyte.  
**NOTE:** Add distilled water in each cell until battery acid reaches the level specified by the battery manufacturer. This helps purge excessive gas from cells. Do not overfill. For a battery without cell caps, carefully follow the battery manufacturer's recharging instructions.
- Gel batteries have the electrolyte in the form of a gel rather than a liquid and do not require topping up. Gel batteries are sealed and the battery caps are not removable.
- AGM (Absorbed Glass Mat) batteries are similar to gel batteries except that the electrolyte is absorbed into a fiberglass matting.
- Custom battery is configured by the dealer, factory, or service center for battery types other than those listed above.
- Lithium iron phosphate (LFP) must only be selected with a lithium-ion Xantrex Battery with BMS. Other lithium-ion batteries with a certified / listed BMS may be considered a Custom battery.

## NOTICE

### BATTERY DAMAGE

Do not mix battery types. The Freedom XC can only select one battery type setting for all batteries connected to its bank. All connected batteries should either be: Flooded (or wet) or Gel or AGM or Custom or LFP.

**Failure to follow these instructions can result in equipment damage.**

## 3-Stage Charging Algorithm

The Freedom XC will charge batteries in a sequence known as three-stage charging. Whenever qualified AC power is present at the inverter/charger's input, it passes power through to the connected load and begins charging the batteries. The charging voltage delivered to the battery depends on the battery's:

- Type setting
- Temperature (by switch setting)
- State of charge

The three automatic stages are:

- Bulk
- Absorption
- Float

See *3-Stage Charging Algorithm* for a graph of the three-stage charging profile.

There is a fourth stage, equalization, which is initialized manually as it is only performed occasionally and only on flooded (or wet) batteries.

The charging cycle is a multistage (three-stage) process. Whenever qualified AC power is present at the inverter/charger's input, it passes power through to the connected load and begins charging the batteries.

*Figure 18 Three-Stage Battery Charging Cycle*

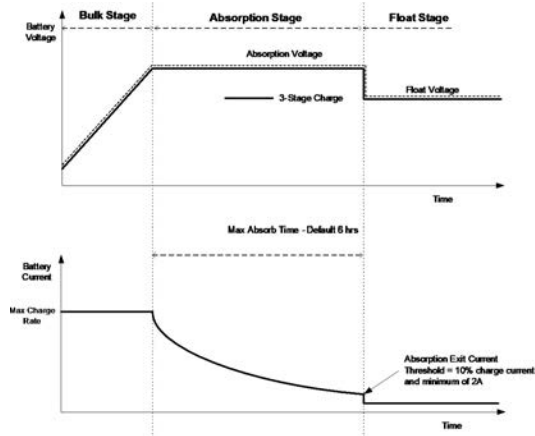

**NOTE:** When the charge cycle is interrupted, the charger will restart charging at the beginning of the multistage algorithm. Charge current during equalize state (optional state not shown here) is normally limited to 10A for 60 min.

### Bulk Stage

Bulk charge is the first stage in the charging process and provides the batteries with a controlled, constant current. Once the battery voltage rises to the absorption voltage threshold, the charger switches to the absorption stage.

### Absorption Stage

During the absorption stage, the Freedom XC begins operating in constant voltage mode and the current falls gradually as the amp hours are returned to the battery.

Table 11 Preset Absorption Voltage Settings

Battery Type	Preset Absorption Voltage
Flooded	14.0V (Hot), 14.4V (Warm), 14.8V (Cold)
Gel	13.8V (Hot), 14.2V (Warm), 14.6V (Cold)
AGM	14.0V (Hot), 14.3V (Warm), 14.6V (Cold)
Custom	14.6 (default), changeable between 12.0 to 18.0

The Freedom XC transitions to the float stage if either one of the following two conditions are met:

- The charge current allowed by the batteries falls below the exit current threshold, which is equal to 10% of the programmed charge current and a minimum of 2A.
- The Freedom XC has been in absorption for the programmed maximum absorption time limit. The default is 6 h.

**NOTE:** If there are DC loads on the batteries, the charger’s current may never decrease to a level to initiate the next stage of charging. In this case, the charger would stay in absorption until the Absorb Time setting is reached.

### Float Stage

Float charge maintains the batteries slightly above the self discharge voltage of the batteries. The charge current in float is the current necessary to maintain the batteries at the Float Voltage setting, limited only by the inverter/charger’s capability or other settings that limit the inverter/charger’s maximum charge rate. Float charging reduces battery gassing, minimizes watering requirements (for flooded batteries), and makes sure the batteries are in a constant state of readiness. The charger automatically switches to the float stage after the batteries have received a bulk and absorption charge (see *Float Stage*). The batteries are maintained at the default float voltage level for the selected battery type or the voltage selected under Float Voltage on the Custom Battery Settings menu.

Table 12 Preset Float Voltage Settings

Battery Type	Preset Float Voltage
Flooded	13.5
Gel	13.8
AGM	13.4
Custom	13.5 (default), changeable between 12.0 to 18.0

**NOTE:** The battery voltage can increase above the float voltage when using an external charging device such as PV arrays, wind turbines, and micro-hydro generators. Be sure to include appropriate charge management equipment with all external DC sources.

## Equalize Charging

Many battery manufacturers recommend periodic equalize charging to counter cell charge imbalance and capacity-robbing electrolyte stratification. Equalizing helps to improve battery performance and lifespan by encouraging more of the battery material to become active.

Battery equalization is a controlled overcharging method that mixes up stratified electrolyte and reactivates unused areas of the plate material. Periodic equalizing can help to regularly restore batteries to a full and healthy state of charge.

Consult the battery manufacturer's recommendation for equalize charging settings. Sealed batteries should **never** be equalized. Consult the battery manufacturer for optimal charging procedures when using Lithium and Sealed batteries.

When Equalization is enabled, the battery is charged from bulk to absorption, and then to the equalize phase. The Freedom XC will transition from the absorption phase to equalize at an equalize current set to 10 A.

After absorption, this constant current charge will continue until the voltage has increased to 16 volts DC.

Equalization duration is fixed at one hour.

Figure 19 Equalize charging

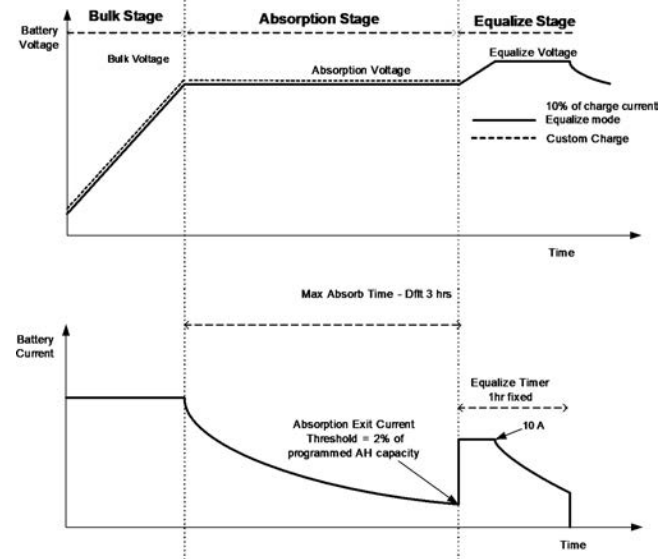

## Custom Battery Settings Menu

### NOTICE

#### REVERSE POLARITY

To avoid damaging your batteries during charging or equalization, consult your battery manufacturer and associated documentation before setting a custom battery type.

**Failure to follow these instructions can result in equipment damage.**

Custom battery type can be selected by the setting number 20 (see *Custom Battery Settings Menu on page 65*). After the custom battery is selected, you can then adjust the value of custom absorption (setting number 22) and custom float (setting number 23) accordingly.

## Operating During Transition Between Grid Mode and Battery Mode

The Freedom XC's advanced power management is capable of transitioning power from an AC source to DC source within a fraction of a second and vice-versa.

The Freedom XC automatically detects when shore power is present and when it becomes unavailable or drops to less than 106 volts AC.

The transfer time can be set to two settings. For details see *Adjusting Settings in Configuration Mode on page 51*.

### NOTICE

#### EQUIPMENT DAMAGE

- When the transfer mode is set to *UPS*, connect only sensitive digital equipment that requires fast AC transfer times.
- Appliances with motors, compressors, and heating elements do not require a transfer mode of *UPS*. Set *RPL* for these devices to avoid damaging the transfer relay.

**Failure to follow these instructions can result in equipment damage.**

## Transitioning from Grid Mode to Battery Mode

When the unit is operating in grid mode and shore power is lost, the Freedom XC has less than 20 milliseconds (default) to switch to operating in battery mode (if the Power button is pressed in the On position) and starts drawing power from the battery.

The operating mode indicator will change to Battery Mode and the green Status LED for Battery Mode will light up.

However, if the Power button is in Standby, this transition does not happen and the display panel turns off.

## Transitioning from Battery Mode to Grid Mode

When the unit is operating in Battery Mode and shore power becomes available, the Freedom XC begins a 20-second countdown to verify the stability of the shore power. If shore power remains stable for a 20-second countdown, at the end of the countdown, the Freedom XC will switch to shore power mode within 20 milliseconds and start drawing power from the AC source.

The operating mode indicator will change to grid mode and the green Status LED for grid mode will light up.

## Operating Limits

These are the operating limits of the Freedom XC:

- *Power Output*
- *Input Voltage*
- *Overload Conditions*
- *High Surge Loads*
- *Over-temperature Conditions*



# Power Output

The Freedom XC can deliver up to 1000 watts (Freedom XC 1000) or 2000 watts<sup>3</sup> (Freedom XC 2000) of continuous utility grade sine wave AC power. The wattage rating applies to resistive loads such as incandescent lights.

# Input Voltage

The allowable Freedom XC input battery voltage ranges are shown in the following table:

Table 13 Input battery voltage range

Operating Condition	Battery Voltage	Comment
Full Operating Range	LBCO – 18.0 volts	Assuming the battery is full, the inverter/charger will operate until battery voltage goes past below LBCO <sup>d</sup> and LBCO Shutdown delay timer <sup>e</sup> .
Low Voltage Recovery	< LBCO+0.2 volts	Inverter is able to recover and continue to operate.

<sup>3</sup> As the temperature on the Freedom XC 2000 rises, it will gradually reduce its continuous power output from 2000 W at 40°C ambient to 1500 W before the over-temperature shutdown occurs at 60°C ambient. See Specifications on page 85.

<sup>d</sup> To set LBCO, see *Adjusting Settings in Configuration Mode* on page 51.  
<sup>e</sup> To set LBCO Shutdown Delay Timer, see *Input Voltage* on page 67.

Operating Condition	Battery Voltage	Comment
Low Voltage Shutdown	< LBCO	The buzzer sounds a single one-second low battery alarm beep and the LCD screen shows error code $E01$ . After LBCO Shutdown delay timer runs out, the unit shuts down inverter output. The buzzer stops beeping and the LCD screen shows error code $E01$ .
Instant Low Voltage Shutdown	< 9.0 volts	After two seconds below the limit, the unit shuts down inverter output completely. LCD screen turns off completely.

Operating Condition	Battery Voltage	Comment
High Voltage Shutdown	18.0 volts	<p>The display shows error code <math>E02</math> alternating with the battery voltage. The red status LED turns on.</p> <p>  </p> <p><b>NOTE:</b> Although the Freedom XC incorporates over-voltage protection, it can still be damaged if input voltage exceeds 18.0 (or 32.0) volts.</p>

## Overload Conditions

There are two kinds of overload conditions – an overload warning and an overload shutdown.

**Overload Warning** When the Freedom XC's AC load is approximately 100 W below the overload shutdown limit of rated watts, the audible alarm beeps once and the LCD screen shows a warning code *E05*.

**Overload Shutdown** When the Freedom XC's AC load increases to near ~1100 W (Freedom XC 1000) and ~2100 W (Freedom XC 2000), the audible alarm beeps every five seconds for one minute and the LCD screen shows a error code *E03*. The Status LED turns solid RED.

## High Surge Loads

Some induction motors used in freezers, pumps, and other motor-operated equipment require high surge currents to start. The Freedom XC may not be able to start some of these motors even though their rated steady state current draw is within the inverter/charger's limits. The unit will shut down and indicate an overload shutdown.

## Over-temperature Conditions

During inverter operation, when the Freedom XC's internal temperature starts to approach its preset shutdown limit, the display will show error code *E07*. If the over-temperature condition persists, the display will show error code *E04*. The Status LED turns solid RED and the inverter/charger will shut down to prevent damage to the inverter/charger and protect the battery from being over-discharged.



---

## 5 ROUTINE MAINTENANCE

Regular maintenance is required to keep your Freedom XC operating properly. This section includes:

**Maintaining the Freedom XC Unit ..... 72**

# Maintaining the Freedom XC Unit

## **WARNING**

### **ELECTRICAL SHOCK HAZARD**

Turning the Power  button to Standby does not disconnect DC battery power from the Freedom XC. You must disconnect from all power sources before working on any circuits connected to the unit.

**Failure to follow these instructions can result in death, serious injury, or equipment damage.**

Periodically you should:

- With all sources of power off, clean the exterior of the unit with a damp cloth to prevent the accumulation of dust and dirt.
- Ensure that the DC cables are secure and fasteners are tight.
- Make sure the ventilation openings are not clogged.

## 6 TROUBLESHOOTING

This section will help you narrow down the source of any problem you encounter. Before contacting customer service, please work through the steps listed in *Pre-service Checklist on page 74*. This section includes:

<b>Pre-service Checklist</b> .....	<b>74</b>
<b>Warning Messages</b> .....	<b>75</b>
<b>Troubleshooting Reference</b> .....	<b>78</b>
<b>Inverter Applications</b> .....	<b>82</b>
Resistive Loads .....	82
Motor Loads .....	82
Problem Loads .....	83

## Pre-service Checklist

### **WARNING**

#### **ELECTRICAL SHOCK HAZARD**

Do not disassemble the Freedom XC. It does not contain any user-serviceable parts. Attempting to service the unit yourself could result in an electrical shock or burn.

**Failure to follow these instructions can result in death, serious injury, or equipment damage.**

**NOTE:** To obtain service go to *Contact Information on page ii*.

Prior to obtaining service, see below:

1. Check for any error codes displayed on the LCD screen. If a message is displayed, record it before doing anything further.
2. As soon as possible, record the conditions at the time the problem occurred so you can provide details when you contact customer service for help. Include the following information:
  - What loads the Freedom XC was running or attempting to run
  - What the battery condition was at the time (voltage, etc.) if known
  - Recent sequence of events
  - Any known unusual AC shore power factors such as low voltage, unstable generator output, etc.

- Whether any extreme ambient conditions existed at the time (temperature, vibrations, moisture, etc.)
3. If your Freedom XC is not displaying an error code, check the following to make sure the present state of the installation allows proper operation:
    - Is the inverter/charger located in a clean, dry, adequately ventilated place?
    - Are the battery cables adequately sized as recommended in the Installation guide?
    - Is the battery in good condition?
    - Are all DC connections tight?
    - Are the AC input and output connections and wiring in good condition?
    - Are the configuration settings correct for your particular installation?
    - Are all disconnects and AC breakers closed and operable?
    - Have any of the fuses/circuit breakers blown in the installation?
  4. Contact customer support for further assistance. Please be prepared to describe details of your system installation and to provide the model and serial number of the unit.



## Warning Messages

Warning messages in the form of audible alarms and error codes that appear on the LCD screen to alert you to an impending system change. Warnings do not affect operation.

With the exception of the error codes displayed on the screen, only the audible alarm can be turned ON or OFF. Follow the steps in *Turning the Audible Alarm ON or OFF on page 60* to change the alarm settings.

The error codes are listed in *Table 14*. The text in the **Error Code** column appears on the LCD screen of the display panel.

Table 14 Error codes displayed on the LCD screen

Error Code	Condition	Mode	Action
E01	Low battery voltage shutdown is imminent depending on the setting, see <i>Maintaining the Freedom XC Unit on page 72</i> .	Battery mode (inverting)	Check battery status and recharge if necessary. Check for proper DC cable sizing. Check for loose connections and tighten if necessary.
E02	High battery voltage shutdown > 18.0 volts DC	Battery mode (inverting)	Check for external charging sources, such as a PV charger and an over voltage alternator. Disconnect, if necessary.
E03	AC output overload shutdown	Battery mode (inverting)	Reduce the loads connected to the AC outlet of the unit. Check appliances that have high-surge ratings and disconnect if necessary.
E04	Over-temperature shutdown	Battery mode (inverting)	Reduce the loads connected to the AC outlet of the unit. Check that the ventilation grille is not blocked. Check for ambient temperature and move the unit to a cooler location whenever possible.
E05	AC output overload warning	Battery mode (inverting)	Reduce the loads connected to the AC outlet of the unit.

Error Code	Condition	Mode	Action
E07	Over-temperature alarm and fan lock alarm	Battery mode (inverting)	Reduce the loads connected to the AC outlet of the unit. Check that the ventilation grille is not blocked. Check for ambient temperature and move the unit to a cooler location whenever possible. Check the fan for any obstruction and remove it.
E08	Fan lock error	Grid mode (bypass)	If there is no issue with the fan, disconnect the unit from its DC and AC power sources, then reconnect, and then restart the unit. Perform <i>Drip Shield Installation on page 42</i> . If error detection persists, contact customer service.
E10 to E19	Internal hardware error	Battery and grid modes	If error detection persists, contact customer service.

For error code E01, after the LBCO shutdown delay, the unit will immediately stop inverting.

For error codes E02 to E04, the unit will stop inverting.

## Troubleshooting Reference

### **WARNING**

#### **ELECTRICAL SHOCK HAZARD**

Do not disassemble the Freedom XC. It does not contain any user-serviceable parts. Attempting to service the unit yourself could result in an electrical shock or burn.

**Failure to follow these instructions can result in death, serious injury, or equipment damage.**

### ***NOTICE***

#### **INVERTER/CHARGER DAMAGE**

Avoid continually overloading the inverter/charger and subjecting it to over temperature conditions. Although provided with integral protection against overloads continual overloading can damage the circuitry.

**Failure to follow these instructions can result in damage to the inverter/charger.**

Table 15 Troubleshooting reference

Problem	Possible Cause	Solution
Alarm does not sound when an error is encountered.	Alarm is turned OFF.	See <i>Turning the Audible Alarm ON or OFF</i> on page 60 and follow instructions to turn the alarm buzzer on again.
No output voltage. The status LED is red.	AC shore power is not available or out of operating range and the inverter/charger has shut down with the LCD screen showing one of the following error codes:	
	Low input voltage (error code E01)	Verify the unit is connected to a 12V battery. Check the DC connections and the cable. Recharge the battery.
	High input voltage (error code E02)	Verify the unit is connected to a 12V battery. Check the voltage regulation of the external charging system (if any).
	Unit overload or AC output short circuit (error code E03)	Reduce the load. Make sure the load does not exceed the output rating.
	Thermal shutdown (error code E04)	Allow the unit to cool off. Reduce the load if continuous operation is required. Improve ventilation. Make sure the inverter/charger's ventilation openings are not blocked.

Problem	Possible Cause	Solution
<p>No output voltage is shown in the LCD screen but the green status LED for Battery mode is illuminated.</p>	<p>Circuit breaker on the AC load panel or AC output disconnect has tripped.</p>	<p>Reset the circuit breaker or check the AC output disconnect circuits.</p>
	<p>Battery voltage is too low (depending on setting, see <i>Maintaining the Freedom XC Unit on page 72</i>) to start inverting. LCD screen may show DC voltage as <i>000</i>.</p>	<p>Check DC connections and cable. Recharge battery.</p>
	<p>GFCI (when installed) has tripped or supplementary breaker has tripped.</p>	<p>Check load and reset the GFCI or supplementary breaker.</p>
<p>No output voltage is shown in the LCD screen and neither of the green status LEDs (for Grid mode and Battery mode) is illuminated.</p>	<p>AC shore power is not available or out of operating range and the inverter/charger is OFF.</p>	<p>Check AC shore power. Turn the inverter/charger ON.</p>
	<p>AC shore power is not available and the inverter/charger is OFF due to a shutdown for more than 30 s.</p>	<p>Check AC shore power and battery voltage. Turn the inverter/charger ON and look at the LCD screen for any error code. <i>See "Error codes displayed on the LCD screen" on page 76.</i></p>

<b>Problem</b>	<b>Possible Cause</b>	<b>Solution</b>
No output voltage. The status LED is not lighting up.	Ignition lock (ACC) signal is not present.	If the ignition control feature is in use, ensure the vehicle's ignition is On and the ignition control switch on the front of the Freedom XC unit is On (I).
The fan turns on and off during AC shore power mode.	The battery is discharged. AC pass-through current is high.	Do not be alarmed, the unit is performing normally.
The fan turns on and off during inverter mode.	The inverter is running continuously at high power.	Do not be alarmed, the unit is performing normally. The fan is activated automatically.

## Inverter Applications

The Freedom XC performs differently depending on the AC loads connected to it. If you are having problems with any of your loads, read this section.

### Resistive Loads

These are the loads that the inverter/charger finds the simplest and most efficient to drive. Voltage and current are in phase (that is, in step with one another). Resistive loads usually generate heat in order to accomplish their tasks. Toasters, coffee pots, and heater elements are typical resistive loads. It is usually impractical to run larger resistive loads—such as electric stoves and water heaters—from an inverter due to their high current requirements. Even though the inverter/charger can most likely accommodate the load, the size of battery bank required would be impractical if the load is to be run for long periods.

### Motor Loads

Induction motors (that is, motors without brushes) require two to six times their running current on start up. The most demanding are those that start under load, for example, compressors and pumps. Of the capacitor start motors (typical in drill presses, band saws, etc.), the largest you can expect to run is ½ hp (the transfer relays are rated at 2 hp). Universal motors are generally easier to start. Since motor characteristics vary, only testing will determine whether a specific load can be started and how long it can be run. If a motor fails to start within a few seconds or loses power after running for a time, it should be turned off. When the inverter/charger attempts to start a load that is greater than it can handle, it will turn itself off after a few seconds.

### Long Transfer Times

The Freedom XC may take a long time (~ 0.1–0.2 s) to transfer to Battery Mode when shore power is cut off while powering a motor load. Motor loads typically “freewheel” when power is removed (for example, a grinder) and causes a longer transfer time. The longer transition from shore power to inverter power may cause connected computers or other sensitive equipment to operate incorrectly. To avoid this effect, do not connect motor loads together with sensitive equipment to the inverter/charger for power.



## Problem Loads

**Very Small Loads** If the power consumed by a device is less than the 25-watt threshold of the power save mode circuitry, and power save mode is enabled, the Freedom XC will not run. Most likely the solution will be to disable power save mode.

**Fluorescent Lights and Power Supplies** Some devices cannot be detected when load sensing. Small fluorescent lights are the most common example. Some computers and sophisticated electronics have power supplies that do not present a load until line voltage is available. When this occurs, each unit waits for the other to begin. To drive these loads, either a small companion load like a light bulb rated for more than 25 W must be used to bring the Freedom XC out of power save mode, or the Freedom XC may be programmed to remain on by disabling power save mode.

**Clocks** You may notice that your clocks are not accurate. Some of the clocks on your appliances may reset when the Freedom XC is in power save mode.

When the Freedom XC is in power save mode, it may fail to start some loads even though the rated wattage on the load is more than 25 W. If these kinds of loads are in the system, follow the suggestions given to eliminate the problem.

If the problem loads cannot be eliminated, there are two work-around solutions:

1. Disable power save mode from *Settings on page 53*, causing the Freedom XC to always remain at full output voltage.
2. Use a search-friendly companion load whose only purpose is to be switched on to wake up the Freedom XC to power the load that is unable to bring the Freedom XC out of power save mode.

### NOTES:

- Power save mode, by function, cannot work with clocks and timers or devices that need power 24 hours a day. Examples of devices with timers include cable TV boxes, coffee makers with brew timers, refrigerators, and freezers with defrost timers. Examples of devices that need power 24 hours a day include telephone answering machines, alarm systems, motion detection lights, and some thermostats.
- When the Freedom XC is load sensing the output for loads, lights that have a wattage lower than 25-watt threshold, may flash momentarily.



# 7 SPECIFICATIONS

This section summarizes the hardware and electrical specifications of the Freedom XC Inverter Charger.

<b>Physical Specifications</b> .....	<b>86</b>
<b>Environmental Specifications</b> .....	<b>87</b>
<b>System Specifications</b> .....	<b>88</b>
<b>Regulatory Approvals</b> .....	<b>92</b>

**NOTE:** Specifications are subject to change without prior notice.

# Physical Specifications

Table 16 Physical specifications

	Freedom XC 1000	Freedom XC 2000
L x W x H	14.2" x 10.6" x 3.7" (360mm x 270mm x 95mm) without flanges	15.4" x 10.8" x 4.0" (390mm x 275mm x 102mm) without flanges
	14.2" x 11.8" x 3.7" (360mm x 300mm x 95mm) with flanges	15.4" x 12" x 4" (390mm x 305mm x 102mm) with flanges
Net Weight	13.4 lbs (6.1 kg)	16.3 lbs (7.4 kg)

Table 17 Product dimensions

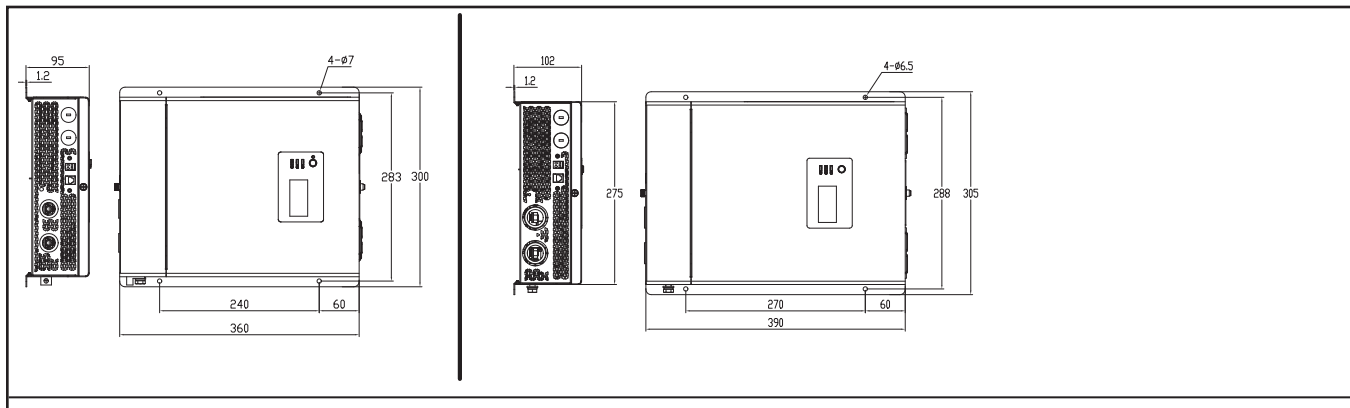

# Environmental Specifications

Table 18 Environmental specifications

	Freedom XC 1000	Freedom XC 2000
Ambient Temperature:		
Operating Temperature Range <sup>a</sup>	-4 –140 °F (-20 –60 °C), with output derated above 104 °F (40 °C)	
Storage Temperature Range	-40 –158 °F (-40 –70 °C)	
Humidity: Operation/Storage	5–95% RH, non-condensing	

<sup>a</sup>Operation may be limited based on the battery chemistry. For example, Lithium Iron Phosphate batteries have a limited charging temperature range. Follow specific battery manufacturer recommendations for the applicable chemistry.

# System Specifications

Table 19 System specifications

	Freedom XC 1000	Freedom XC 2000
Transfer relay rating (A <sup>a</sup> )	30A (24A continuous)	
Transfer time (milliseconds <sup>b</sup> )		
Shore to inverter:	<20 milliseconds	
Inverter to shore:	<20 milliseconds with a 20-second delay	
Transfer voltage (V)		
Shore to inverter:	<85 V and >140 V	
Inverter to shore:	<135 V and >90 V	
Cooling	Fan, activated by any of the following: High internal temperature High AC output power	

<sup>a</sup> Circuit breakers shall not carry more than 80% of their UL current rating continuously.

<sup>b</sup> To change the AC Transfer time (mode), see *Adjusting Settings in Configuration Mode* on page 51.

*Table 20 DC input for inverting*

	<b>Freedom XC 1000</b>	<b>Freedom XC 2000</b>
Operating voltage range	LBCO voltage <sup>a</sup> –18.0 VDC	
Maximum non-operating voltage	24 VDC	24 VDC
Nominal voltage	12.0 VDC	12.0 VDC
Nominal current at full load	100 ADC	192 ADC

---

<sup>a</sup>To set LBCO, see *Adjusting Settings in Configuration Mode* on page 51.

Table 21 AC output for inverting

	Freedom XC 1000	Freedom XC 2000
Output voltage options	120, 110, 108 VAC	
Continuous power <sup>b</sup>	1000 W @ 40 °C	2000 W @ 40 °C
Continuous current	8.4 A	16.7 A
Surge power (2 sec)	2000 W	4000 W
Frequency	60 (or 50) Hz	60 (or 50) Hz
GFCI protection <sup>c</sup>	customer-provided	customer-provided
Wave shape	True Sine Wave	True Sine Wave
Peak efficiency	91%	91%
Full load efficiency	≥ 87.3%	≥ 87.5%

Table 22 AC input for charging

	Freedom XC 1000	Freedom XC 2000
Operating voltage range	85–140 VAC	85–140 VAC
Safe non-operating voltage range	up to 240 VAC	up to 240 VAC
Full load maximum current	7 Arms	11 Arms

<sup>b</sup> Power derates to 85% when output voltage is set to 110/108 VAC. .

<sup>c</sup> See *Ground Fault Circuit Interrupters (GFCIs)* on page 20 for approved device/s.



	Freedom XC 1000	Freedom XC 2000
Nominal frequency	60 (or 50) Hz	60 (or 50) Hz
Power factor at full charge	> 98%	> 98%

*Table 23 DC output for charging*

	Freedom XC 1000	Freedom XC 2000
Nominal voltage	12.0 VDC	12.0 VDC
Min battery voltage for charging	0.0 VDC	0.0 VDC
Max output voltage	18.0 VDC (custom battery type)	18.0 VDC (custom battery type)
Nominal output current	User selectable: 5 to 50A <sup>d</sup>	User selectable: 5 to 80A <sup>e</sup>
Charger current derating	May reduce charger current depending on ambient temperature.	May reduce charger current depending on ambient temperature.
Efficiency at nominal output	≥90.1%	≥91%

<sup>d</sup>Charger current is rated to 14.4 VDC output only. The charger derates if a high DC output voltage is selected.

<sup>e</sup>Charger current is rated to 14.4 VDC output only. The charger derates if a high DC output voltage is selected.

# Regulatory Approvals

Table 24 Regulatory approvals

	<b>Freedom XC 1000</b>	<b>Freedom XC 2000</b>
Product Safety	ETL-listed complies to CSA 107.1 UL458 and UL458 Marine Supplement (drip shield with product number 808-1050 required) ABYC E-11, A-31, A-32	ETL-listed complies to CSA 107.1 UL458 and UL458 Marine Supplement (drip shield with product number 808-1050 required) ABYC E-11, A-31, A-32
EMI	CFR 47, (FCC Part 15) Subpart B, Class B ISED CAN ICES-3(B)/NMB-3(B)	CFR 47, (FCC Part 15) Subpart B, Class B ISED CAN ICES-3(B)/NMB-3(B)



# xantrex™

A MISSION CRITICAL ELECTRONICS BRAND

Smart choice for power™

<http://www.xantrex.com/>

(Toll Free USA/Canada) +1 800 670 0707

(Outside USA/Canada) +1 408 987 6030

975-0784-01-01 Rev D

Printed in: